

# TASCAM

TEAC Professional Division

# 424MKIII

# PORTASTUDIO

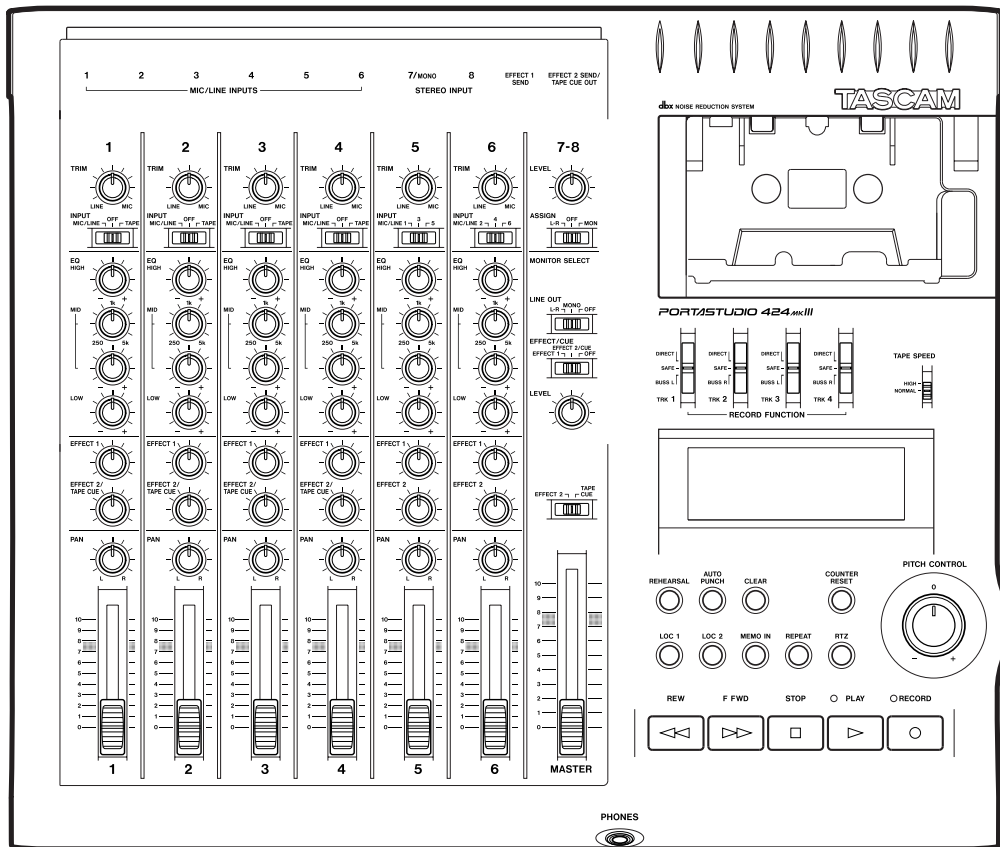

## OWNER'S MANUAL

3D0023100A

# Table Of Contents

<b>Safety Instructions</b>	<b>3</b>	<b>Using Effects with the</b>	
<b>Introduction</b>	<b>4</b>	<b>PORTASTUDIO 424 MKIII</b>	<b>35-36</b>
<b>The Recording System</b>	<b>5</b>	Setting effect send levels	35
The three steps to multitrack	5	Setting the output level of effect devices	35
<b>Understanding the Mixer</b>	<b>6-7</b>	Setting the mix/balance control	
Signal flow in the 424 MKIII mixer	6	on effect devices	35
Tape cue monitor system	7	How to connect your effects devices	36
<b>Multitrack Cassette Recorder</b>	<b>8</b>	<b>Syncing MIDI-Tape—Using the</b>	
<b>Track Format and Tape Recommendations</b>	<b>9-10</b>	<b>TASCAM MTS-30</b>	<b>37</b>
<b>PORTASTUDIO 424 MKIII Brief Guide</b>	<b>11-14</b>	<b>Troubleshooting</b>	<b>38</b>
<b>Step-By-Step Operations Guide</b>	<b>15-24</b>	<b>Features and Controls</b>	<b>39-45</b>
Let's try the 424 MKIII mixer	15	424 MKIII Mixer	
How to record on track 1	16	Input section	40
Track 1 playback through TAPE CUE	18	Stereo input section	41
How to make an overdub on track 2	19	Monitor section	41
How to record tracks 3 and 4	20	Master section	41
How to record many sources onto a		Output section	41
single track	20	424 MKIII Recorder	
How to record a mix onto two tracks		Cassette loading and dbx system	42
simultaneously	21	Transport controls	43
Recording on more than two tracks		Track controls	44
simultaneously : DIRECT	22	Displays	44
How to mix down	23	Autolocators	44
<b>Using Memory Location Points</b>	<b>25-26</b>	<b>Optional Accessories</b>	<b>47</b>
Loading MEMO points	25	<b>Care and Maintenance</b>	<b>48-49</b>
Locating the tape	26	<b>How the dbx Works</b>	<b>49</b>
<b>Repeat Play</b>	<b>27</b>	<b>Specifications</b>	<b>50-52</b>
<b>PUNCH-IN or INSERT Recording</b>	<b>28-32</b>	<b>Block Diagram</b>	<b>53-54</b>
Preliminary	28	<b>Level Diagram</b>	<b>55</b>
Rehearsal and auto in/out procedures	29		
Manual punch-in	31		
<b>Bouncing Tracks (Ping-Pong)</b>	<b>33-34</b>		
Ping-pong procedure	33		

"© Copyright 1998, TEAC Corporation"

All rights reserved under international and Pan American copyright conventions.

This book may not be reproduced in whole or in part, by mimeograph or any other means, without permission.

"The following marking is located on the bottom of the unit."



CAUTION: TO REDUCE THE RISK OF ELECTRIC SHOCK, DO NOT REMOVE COVER (OR BACK). NO USER-SERVICEABLE PARTS INSIDE. REFER SERVICING TO QUALIFIED SERVICE PERSONNEL.



The lightning flash with arrowhead symbol, within equilateral triangle, is intended to alert the user to the presence of uninsulated "dangerous voltage" within the product's enclosure that may be of sufficient magnitude to constitute a risk of electric shock to person.



The exclamation point within an equilateral triangle is intended to alert the user to the presence of important operating and maintenance (servicing) instructions in the literature accompanying the appliance.

This appliance has a serial number located on the rear panel. Please record the model number and serial number and retain them for your records.  
 Model number \_\_\_\_\_  
 Serial number \_\_\_\_\_

**WARNING: TO PREVENT FIRE OR SHOCK HAZARD, DO NOT EXPOSE THIS APPLIANCE TO RAIN OR MOISTURE.**

# Safety Instructions

## CAUTION:

- Read all of these Instructions.
- Save these Instructions for later use.
- Follow all Warnings and Instructions marked on the audio equipment.

- 1) **Read instructions** — All the safety and operating instructions should be read before the product is operated
- 2) **Retain instructions** — The safety and operating instructions should be retained for future reference
- 3) **Heed Warnings** — All warnings on the product and in the operating instructions should be adhered to
- 4) **Follow instructions** — All operating and use instructions should be followed
- 5) **Cleaning** — Unplug this product from the wall outlet before cleaning. Do not use liquid cleaners or aerosol cleaners. Use a damp cloth for cleaning.
- 6) **Attachments** — Do not use attachments not recommended by the product manufacturer as they may cause hazards
- 7) **Water and Moisture** — Do not use this product near water — for example, near a bath tub, wash bowl, kitchen sink, or laundry tub; in a wet basement; or near a swimming pool; and the like
- 8) **Accessories** — Do not place this product on an unstable cart, stand, tripod, bracket, or table. The product may fall, causing serious injury to a child or adult, and serious damage to the product. Use only with a cart, stand, tripod, bracket, or table recommended by the manufacturer, or sold with the product. Any mounting of the product should follow the manufacturer's instructions, and should use a mounting accessory recommended by the manufacturer
- 9) A product and cart combination should be moved with care. Quick stops, excessive force, and uneven surfaces may cause the product and cart combination to overturn



- 10) **Ventilation** — Slots and openings in the cabinet are provided for ventilation and to ensure reliable operation of the product and to protect it from overheating, and these openings must not be blocked or covered. The openings should never be blocked by placing the product on a bed, sofa, rug, or other similar surface. This product should not be placed in a built-in installation such as a bookcase or rack unless proper ventilation is provided or the manufacturer's instructions have been adhered to
- 11) **Power Sources** — This product should be operated only from the type of power source indicated on the marking label. If you are not sure of the type of power supply to your home, consult your product dealer or local power company. For products intended to operate from battery power, or other sources, refer to the operating instructions
- 12) **Grounding or Polarization** — This product may be equipped with a polarized alternating-current line plug (a plug having one blade wider than the other). This plug will fit into the power outlet only one way. This is a safety feature. If you are unable to insert the plug fully into the outlet, try reversing the plug. If the plug should still fail to fit, contact your electrician to replace your obsolete outlet. Do not defeat the safety purpose of the polarized plug
- 13) **Power-Cord Protection** — Power-supply cords should be routed so that they are not likely to be walked on or pinched by items placed upon or against them, paying particular attention to cords at plugs, convenience receptacles, and the point where they exit from the product
- 14) **Outdoor Antenna Grounding** — If an outside antenna or cable system is connected to the product, be sure the antenna or cable system is grounded so as to provide some protection against voltage surges and built-up static charges. Article 810 of the National Electrical Code, ANSI/NFPA 70, provides information with regard to proper grounding of the mast and supporting structure, grounding of the lead-in wire to an antenna discharge unit, size of grounding conductors, location of antenna-discharge unit, connection to grounding electrodes, and requirements for the grounding electrode

## "Note to CATV system installer:

This reminder is provided to call the CATV system installer's attention to Section 820-40 of the NEC which provides guidelines for proper grounding and, in particular, specifies that the cable ground shall be connected to the grounding system of the building, as close to the point of cable entry as practical

### Example of Antenna Grounding as per National Electrical Code, ANSI/NFPA 70

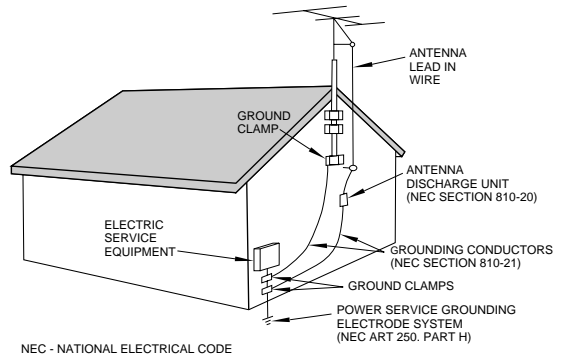

- 15) **Lightning** — For added protection for this product during a lightning storm, or when it is left unattended and unused for long periods of time, unplug it from the wall outlet and disconnect the antenna or cable system. This will prevent damage to the product due to lightning and power-line surges
- 16) **Power Lines** — An outside antenna system should not be located in the vicinity of overhead power lines or other electric light or power circuits, or where it can fall into such power lines or circuits. When installing an outside antenna system, extreme care should be taken to keep from touching such power lines or circuits as contact with them might be fatal
- 17) **Overloading** — Do not overload wall outlets, extension cords, or integral convenience receptacles as this can result in risk of fire or electric shock
- 18) **Object and Liquid Entry** — Never push objects of any kind into this product through openings as they may touch dangerous voltage points or short-out parts that could result in a fire or electric shock. Never spill liquid of any kind on the product
- 19) **Servicing** — Do not attempt to service this product yourself as opening or removing covers may expose you to dangerous voltage or other hazards. Refer all servicing to qualified service personnel
- 20) **Damage Requiring Service** — Unplug this product from the wall outlet and refer servicing to qualified service personnel under the following conditions:
  - a) when the power-supply cord or plug is damaged
  - b) if liquid has been spilled, or objects have fallen into the product
  - c) if the product has been exposed to rain or water
  - d) if the product does not operate normally by following the operating instructions. Adjust only those controls that are covered by the operating instructions as an improper adjustment of other controls may result in damage and will often require extensive work by a qualified technician to restore the product to its normal operation
  - e) if the product has been dropped or damaged in any way
  - f) when the product exhibits a distinct change in performance — this indicates a need for service
- 21) **Replacement Parts** — When replacement parts are required, be sure the service technician has used replacement parts specified by the manufacturer or have the same characteristics as the original part. Unauthorized substitutions may result in fire, electric shock, or other hazards
- 22) **Safety Check** — Upon completion of any service or repairs to this product, ask the service technician to perform safety checks to determine that the product is in proper operating condition
- 23) **Wall or Ceiling Mounting** — The product should be mounted to a wall or ceiling only as recommended by the manufacturer
- 24) **Heat** — The product should be situated away from heat sources such as radiators, heat registers, stoves, or other products (including amplifiers) that produce heat

# Introduction

---

## The PORTASTUDIO 424 MKIII is...

The PORTASTUDIO 424 MKIII is a 4-track "Multitrack Master" cassette tape recorder and a full-function mixer with 8 inputs/stereo outputs combined into a single workstation.

Its high audio quality and creative flexibility reflect the experience and innovation that have allowed TASCAM to earn its reputation in professional audio production fields, and its user-friendly design makes the 424 MKIII suitable for anyone, from expert to novice.

**Using this manual :** To get the most out of your 424 MKIII, please take the time to read through this manual. Some time spent now will keep you from overlooking some of the features that make the 424 MKIII a more creative tool. You may discover some new tricks you haven't tried before.

**Use of capital letters :** In general, we use all upper case type to designate a particular switch, control, jack name or label (like PAN). Transport modes and some features are described with an upper case first letter (like Record mode).

**CAUTION :** TO PREVENT ELECTRIC SHOCK, MATCH WIDE BLADE OF PLUG TO WIDE SLOT, FULLY INSERT

**ATTENTION :** POUR ÉVITER LES CHOCS ÉLECTRIQUES, INTRODUIRE LA LAME LA PLUS LARGE DE LA FICHE DANS LA BORNE CORRESPONDANTE DE LA PRISE ET POUSSER JUSQU' AU FOND.

### About the weld line

There is a patterned stripe-like effect on the bottom surface of the 424 unit. This effect is called a "weld line" and is a natural result of the resin molding process employed in the manufacture of the 424 unit. It is not a crack or scratch, and will cause no problems with the operation of the 424 unit.

## NOTE FOR U.K. CUSTOMERS

**DO NOT cut off the mains plug from this equipment.** If the plug fitted is not suitable for the power points in your home or the cable is too short to reach a power point, then obtain an appropriate safety approved extension lead or consult your dealer.

If nonetheless the mains plug is cut off, remove the fuse and dispose of the plug immediately, to avoid a possible shock hazard by inadvertent connection to the mains supply.

If this product is not provided with a mains plug, or one has to be fitted, then follow the instructions given below:

**IMPORTANT. DO NOT** make any connection to the larger terminal which is marked with the letter E or by the safety earth symbol  $\perp$  or coloured GREEN or GREEN-and-YELLOW.

The wires in the mains lead on this product are coloured in accordance with the following code:

BLUE:            NEUTRAL  
BROWN:        LIVE

As these colours may not correspond with the coloured markings identifying the terminals in your plug proceed as follows:

The wire which is coloured BLUE must be connected to the terminal which is marked with the letter N or coloured BLACK.

The wire which is coloured BROWN must be connected to the terminal which is marked with the letter L or coloured RED.

When replacing the fuse only a correctly rated approved type should be used and be sure to re-fit the fuse cover.

**IF IN DOUBT — CONSULT A COMPETENT ELECTRICIAN.**

# The Recording System

The PORTASTUDIO 424 MKIII is a complete audio production facility in a single box. It is divided into two major sections: a full-function mixer and an 4-channel, multitrack cassette recorder.

To complete the recording system, you'll additionally need these: Input devices (microphones, instruments), Output devices (headphones), 2 track recorder, Effects processors, etc.

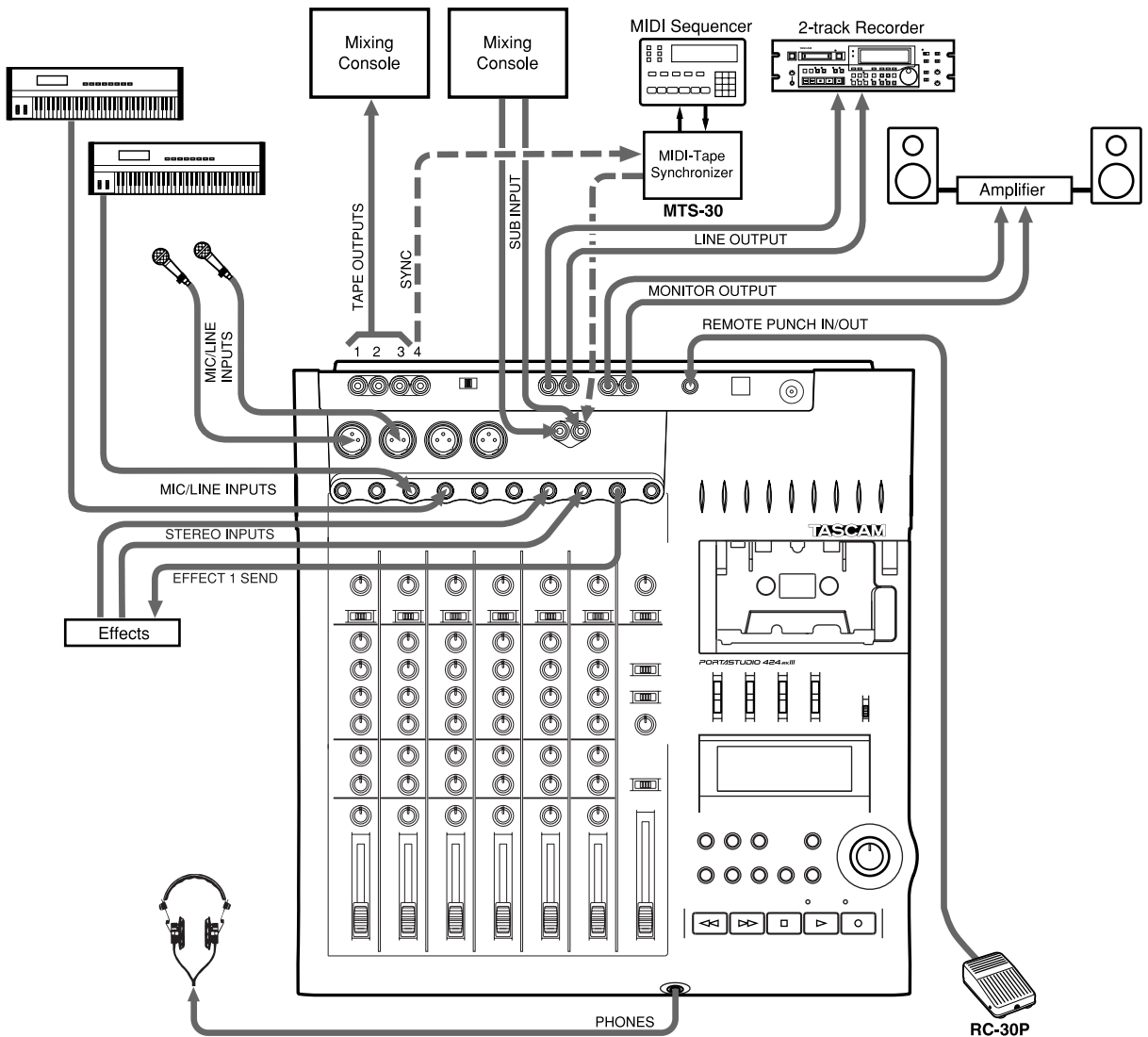

## The Three Steps to Multitrack

In **TRACKING** and **Overdubbing**, the mixer inputs are usually microphones or instruments, going to different tracks of the recorder.

In **OVERDUBBING**, the **MONITOR** section and **TAPE CUE** of the mixer must be used to listen to previous tracks while you record new ones, so there is a two-way flow through the console.

In **MIXDOWN**, signal comes from the multitrack and is sent to an external 2-track recorder.

# Understanding the Mixer

## Signal Flow in the 424 MKIII Mixer

The illustration below shows how input signals pass through the 424 MKIII Mixer section. After the MASTER fader they go to the L/R LINE OUT

jacks. This is the most important signal route in the mixer and is called "Main Mix".

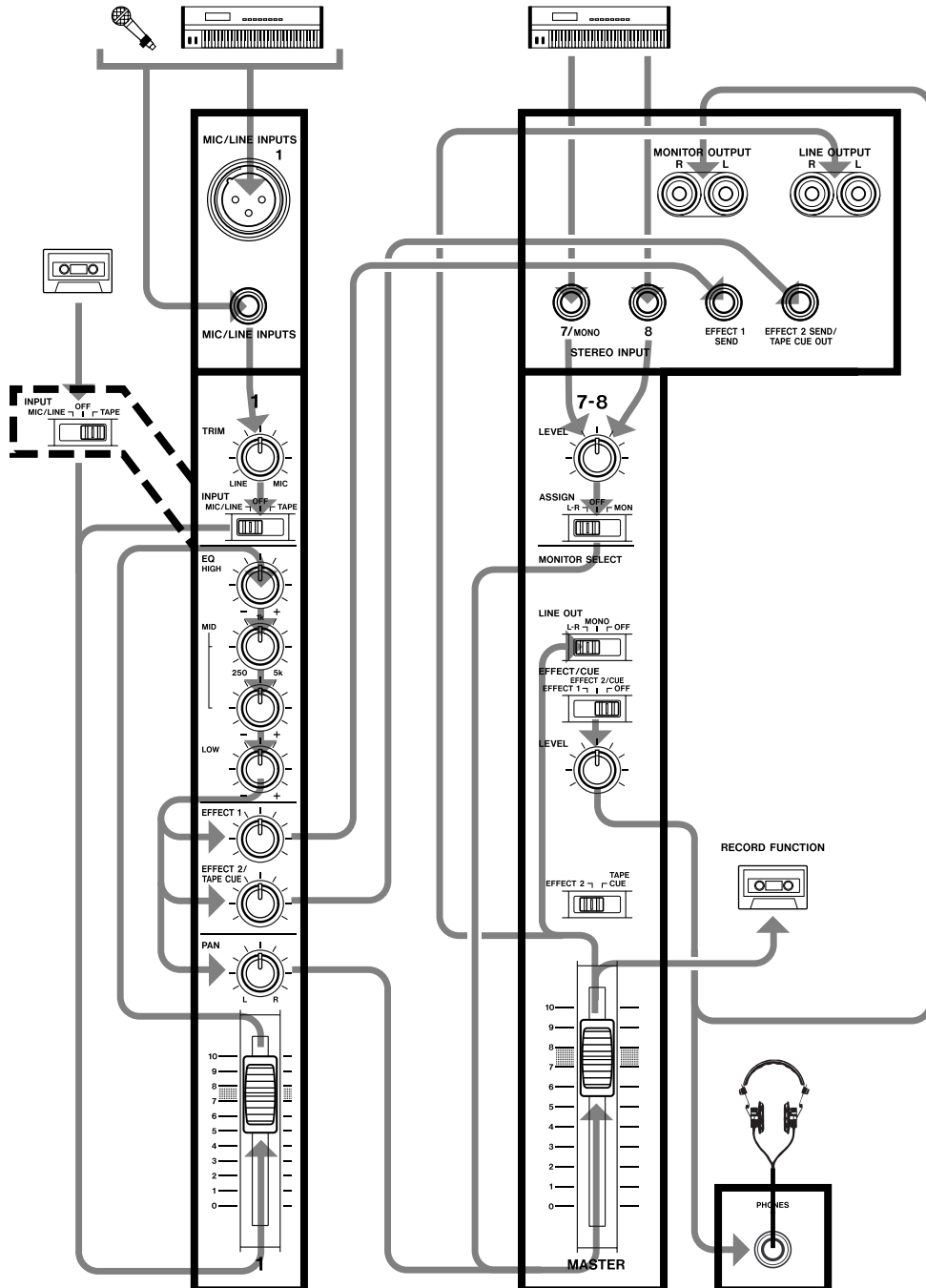

## Tape Cue Monitor System

The TAPE CUE mix and MONITOR switches are also crucial for successful multitrack recording, because they control what you hear in the headphones. This CUE mix is totally independent from the Main Mix going to tape. If you don't use the CUE mix, you run the risk of accidentally "bouncing tracks" every time you record new material.

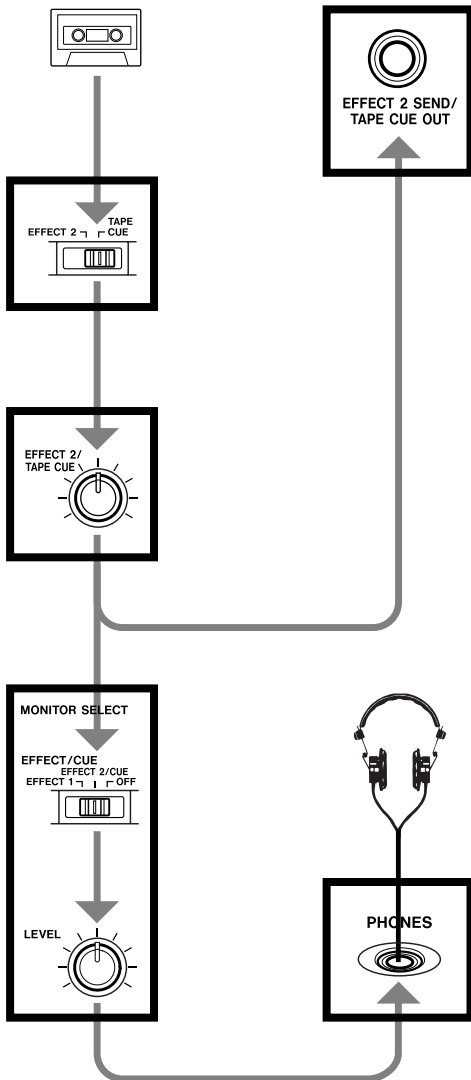

The 4 TAPE CUE controls act like a separate 4x1 mixer, dedicated solely to enabling you to hear playback from the multitrack recorder in your headphones. The settings of these controls don't affect the mix going to tape. When the EFFECT/CUE switch is set to the center position (EFFECT 2/CUE), the EFFECT 2/TAPE CUE switch is set to TAPE CUE, the TAPE CUE of the tracks you want to hear are turned clockwise, and the MONITOR LEVEL is turned up, you can hear the tape playback in the headphones and MONITOR outputs. You can adjust the monitor level of each track by adjusting its TAPE CUE control. The channels of the Main Mix remain free to handle external inputs for recording.

If you can hear tape playback in your headphones when TAPE CUE is off (in the left position), it means you're hearing tape through the Main Mix. This is correct for mixdown and bouncing tracks, but during overdubbing it can cause previous tracks to be mixed together with new tracks, instead of each part remaining separate. Use the TAPE CUE to avoid this.

The MONITOR SELECT LINE OUT switch affects whether you will hear the off-tape signal (OFF), or the LINE OUT signals in MONO or stereo (L-R). When you are recording, you should set this switch to OFF, the EFFECT/CUE switch to EFFECT 2/CUE, and the EFFECT 2/TAPE CUE switch to TAPE CUE.

# Multitrack Cassette Recorder

---

The 424 MKIII records on readily available standard (Philips) Compact Cassette tape, high bias Type II. The recorder has 4 tracks while the mixer has a stereo output; however, using the DIRECT feature you can record on any or all of the 4 tracks at one time. For more details, see "Recording on More Than Two Tracks Simultaneously", page 22.

The 424 MKIII's dbx Noise Reduction virtually eliminates unwanted tape noise. A special SYNC feature turns off the dbx on track 4 separately, making it possible to record and play back the MIDI sync tones or SMPTE/EBU time code without being affected by the dbx encode/decode. This ensures that the sync tones/code are recorded and played back without unnecessary processing. With proper operating techniques, it is not necessary to leave a guard band between music and sync tone tracks because of the low crosstalk of the TASCAM heads.

The transport controls of the 424 MKIII are micro-processor operated, allowing highly reliable functions that make the unit easier to use:

- A three-point autolocator (MEMO/LOC 1 and 2 and RTZ) lets the tape STOP at, or PLAY from preset points.
- REPEAT allows a section to be played over and over between the MEMO 1 and MEMO 2 points.
- REHEARSAL programs the 424 MKIII to repeat a punch-in/out sequence as many times as you wish, and AUTO PUNCH actually executes it on tape exactly as you "previewed" in REHEARSAL.
- Two tape speeds offer HIGH for greater fidelity, and NORMAL for compatibility with standard cassette tapes.
- The tape speed can be increased or decreased with the PITCH CONTROL dial in both playback and record, to match pitch or for special effects.



# Track Format and Tape Recommendations

## Tape Speed and Track Format

The Portastudio 424 MKIII uses a HIGH speed of 9.5 cm/sec. (3-3/4 inches per second) which is two times (2X) the normal speed of a standard audio cassette. Its NORMAL speed is 4.8 cm/sec (1-7/8 i.p.s.), the same as that used by conventional recorders.

It also employs a discrete 4-channel format head developed especially by TEAC for TASCAM multitrack cassette recorders. Here is a comparison of various cassette formats:

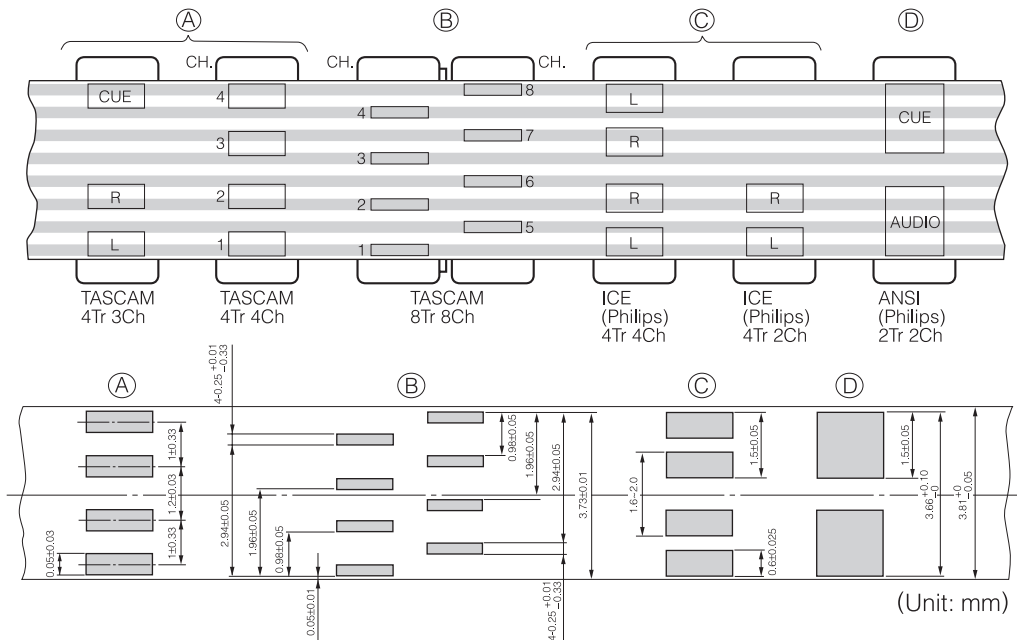

**Playing back standard (stereo) prerecorded tapes:** Tapes recorded on stereo cassette recorders can play back properly on the 424 MKIII if you set the track playback, tape speed, and noise reduction type correctly. Tracks 1 and 2 roughly follow the standard "stereo" format, but tracks 3 and 4 use the "Side B" (reverse side) tracks. So you must turn off Track 3-4 playback to avoid hearing the flip side playing backwards. If the cassette was recorded with Dolby B type noise reduction, the DBX NR switch should be set to OFF.

For the same reasons, tapes recorded on the Portastudio 424 MKIII will not play back properly on stereo cassette recorders. Material recorded on the 424 MKIII must be mixed down to stereo for final distribution.

The 424 MKIII needs the entire width of the tape to record its four tracks, eliminating the option of recording on both sides (actually, it's both directions). Therefore, you should decide which

side (side "A" or side "B") you want to use and use that side exclusively. It's a good idea to get into habit of consistently using the same side on all multitrack tapes.

## Tape Type

The Portastudio 424 MKIII is internally adjusted for HIGH BIAS Type II tape. This means that for best results, you should only use tapes of this type. TDK SA, Maxell XL-II or equivalent formulations are recommended. We strongly suggest that you select one good quality brand and use it exclusively. The time you spend creating your multitrack master is much more valuable than the money you save by buying inferior tape. The cassette shell essentially becomes a part of the 424 MKIII's transport. Poor quality shells can cause wrinkles, snarls and shredding of the edges of the tape with use. Even small scratches on the tape oxide can cause "dropouts" (temporary loss of signal) on one or more tracks. High quality tapes are less likely to cause problems in the long run.

---

### Accidental Erase/Record Protection

To protect a finished master tape, it is necessary to punch out both record protect tabs. Even though you are recording in only one direction, the 424 MKIII uses the entire width of the tape, as mentioned above. If, for example, you remove only one of the tabs, you could accidentally insert the cassette into the 424 MKIII backwards and erase all four tracks of the master.

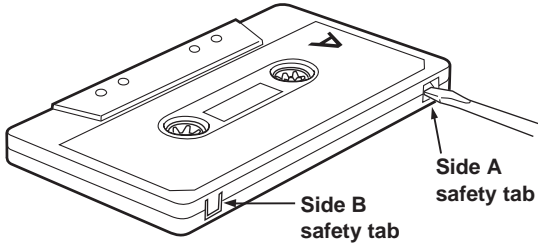

### Tape Length

Use the shortest possible tape for a given work. It is not unusual to play a tape 100 times before you are finished, so select a cassette length that is as close as possible to the length of the program you plan to record. Cassettes C-60 length and shorter are often made from thicker stock than longer cassettes.

The tape used in C-120 cassettes is extremely thin and can cause winding problems, crimping, wrinkling, and other damage to the oxide coating of the tape which will destroy your work. Don't use C-120s in the 424 MKIII.

Remember that at 2X normal speed, and the "one-side-only" 4-track single direction format means that you have only one quarter of the normal play time:

(approx.)

Tape Speed	9.5 cm/sec.	4.8 cm/sec.
C-46	11.5 min.	23 min.
C-60	15 min.	30 min.
C-90	22.5 min.	45 min.

**Input Selection and Adjustment**

**Ch.1-4**

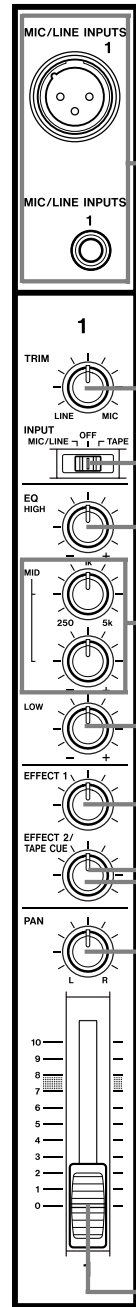

**MIC/LINE INPUTS:** These are the input jacks for the mixer channels. Primarily, the 3-contact, XLR-type connectors are for connection to balanced microphones, and the 1/4" jacks are for line-level, unbalanced signal sources (such as electronic instruments). But you can also connect lower-level signals (down to -50 dBV) to these 1/4" jacks and use the TRIM control to amplify them.

**NOTE**  
DO NOT use both the XLR and 1/4" jacks in the same channel at one time. Disconnect one when the other is used.

**TRIM :** Sets how much preamplification will be added to the MIC/LINE IN jack. Turn to the right if the signal needs amplification, to the left if the signal is so loud it is distorting the mixer electronics.

**INPUT :** Determines where the channel signal comes from.

**MIC/LINE (left)** brings the mic/line input into the channel.

**OFF (center)** shuts off the channel.

**TAPE (right)** makes tape play back the channel source.

**EQ HIGH :** Cuts or boosts treble frequencies. Shelving point is at 10 kHz.

**EQ MID sweep :** The upper control sets the frequency range, centered from 250 Hz to 5 kHz. The lower control cuts or boosts this frequency range.

**EQ LOW :** Cuts or boosts bass frequencies. Shelving point is at 100 Hz.

**EFFECT 1 and 2 :** These control how much signal will go to the corresponding EFFECT send jacks. They get their signal from a point just after the channel fader.

**TAPE CUE :** The EFFECT 2 controls can be switched to act as the TAPE CUE level controls (by means of the correspondingly labeled switch) and adjust the playback level for the musicians in the studio.

**PAN :** Sets the pan position (left-right balance) of the channel. Note that the Left Mix can be recorded on tracks 1 and 3, and the Right Mix onto tracks 2 and 4.

**Channel fader :** Sets the volume of the channel feeding the MASTER fader.

**Ch.5-6**

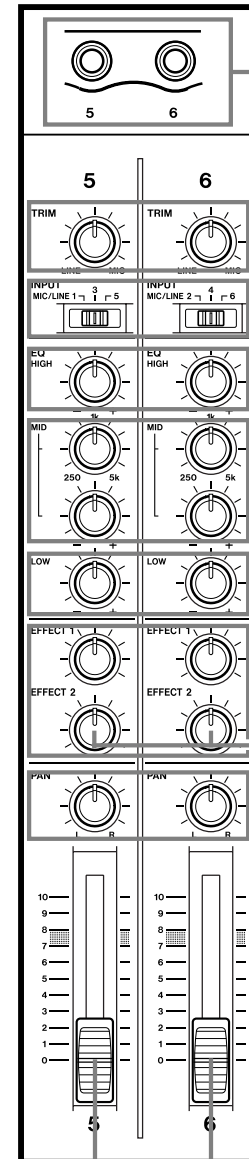

**1/4" STEREO INPUTS :** Primarily used for connecting line-level sources. However, you can also connect lower-level signals (down to -50 dBV) to these 1/4" jacks and use the TRIM level to amplify them.

**TRIM:** Sets how much preamplification will be added to the MIC/LINE IN jack. Turn to the right if the signal needs amplification, to the left if the signal is so loud it is causing distortion in the mixer electronics.

**INPUT:** Determines the source of the channel signals.

**MIC/LINE 1/3/5 (channel 5):** Allows you to choose whether the signal handled by channel 5 comes from either of the MIC/LINE inputs of channel 1, either of the MIC/LINE inputs of channel 3, or the MIC/LINE input of channel 5.

**MIC/LINE 2/4/6 (channel 6):** Allows you to choose whether the signal handled by channel 6 comes from either of the MIC/LINE inputs of channel 2, either of the MIC/LINE inputs of channel 4, or the MIC/LINE input of channel 6.

**EQ HIGH:** Cuts or boosts treble frequencies. Shelving point is at 10 kHz.

**EQ MID (sweep):** The upper control sets the frequency range, centered from 250 Hz to 5 kHz. The lower control cuts or boosts this frequency range.

**EQ LOW:** Cuts or boosts bass frequencies. Shelving point is at 100 Hz.

**EFFECT 1 and 2:** These control how much signal will go to the corresponding EFFECT SEND jacks. They get their signal from a point just after the channel fader.

**TAPE CUE:** The EFFECT 2 controls can be switched to act as the TAPE CUE level controls (by means of the correspondingly labeled switch) and adjust the playback level for the musicians in the studio.

**PAN:** Sets the pan position (left-right balance) of the channel. Note that the Left Mix can be recorded on tracks 1 and 3, and the Right Mix onto tracks 2 and 4.

**Channel fader:** Sets the volume of the channel feeding the MASTER fader.

**Ch 7-8**

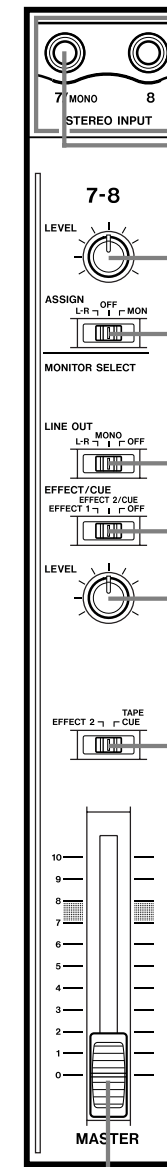

**STEREO INPUT:** Connect any stereo line-level signal (such as an effect return or electronic instrument) here. Alternatively, you can connect two mono line-level signals.

**MONO feature:** If only one mono signal is to be connected, connect it to the L jack, and leave the R jack unconnected. The signal is automatically taken to both the 7 and 8 channels.

**LEVEL:** Controls the volume of both of the inputs simultaneously. The signal is sent to the destination selected by the ASSIGN switch.

**ASSIGN:** This sends the signal(s) at the STEREO INPUT to the stereo mix for recording (L-R) or to the monitor mix (MON), or turns the signals OFF (center).

**Monitor Section**

**LINE OUT switch:** Controls whether the LINE OUT stereo mix will be output to the monitor mix, in stereo (L-R), in mono (MONO) or not at all (OFF).

**EFFECT/CUE switch:** Controls whether the signals sent to EFFECT 1 or EFFECT 2/CUE or neither (OFF) will be output to the monitor mix, or you may select neither of these for monitoring (OFF).

**LEVEL:** Controls the level of the monitor mix feeding the MONITOR OUT jacks and headphones.

**Master Section**

**EFFECT 2/TAPE CUE switch:** This alters the function of the four level controls immediately above the pan controls of channels 1 through 4.

**MASTER fader:** This sets the total output level of the stereo mix.

# PORTASTUDIO 424 MKIII Brief Guide

## Recorder Controls

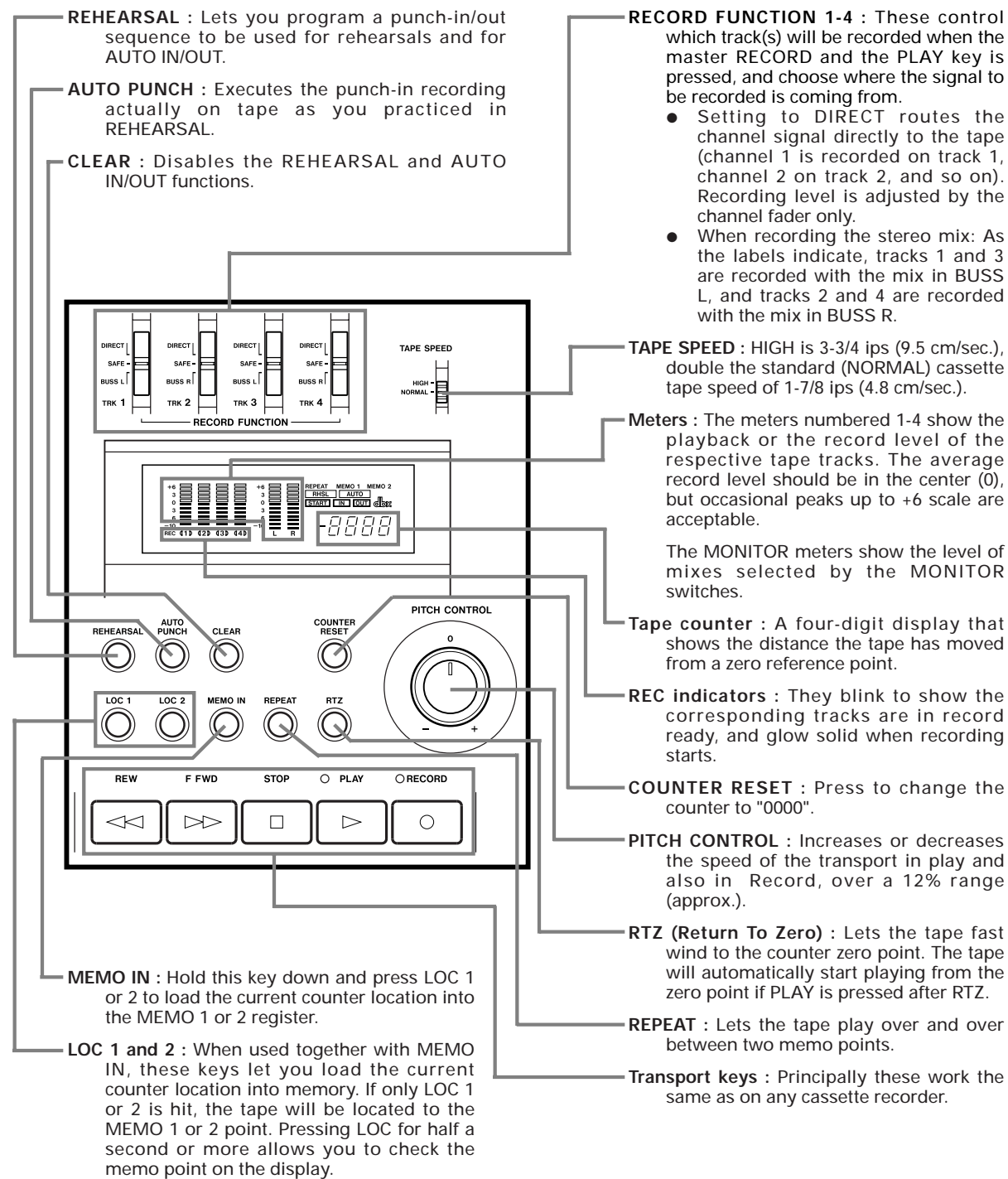

## Rear Panel Connections

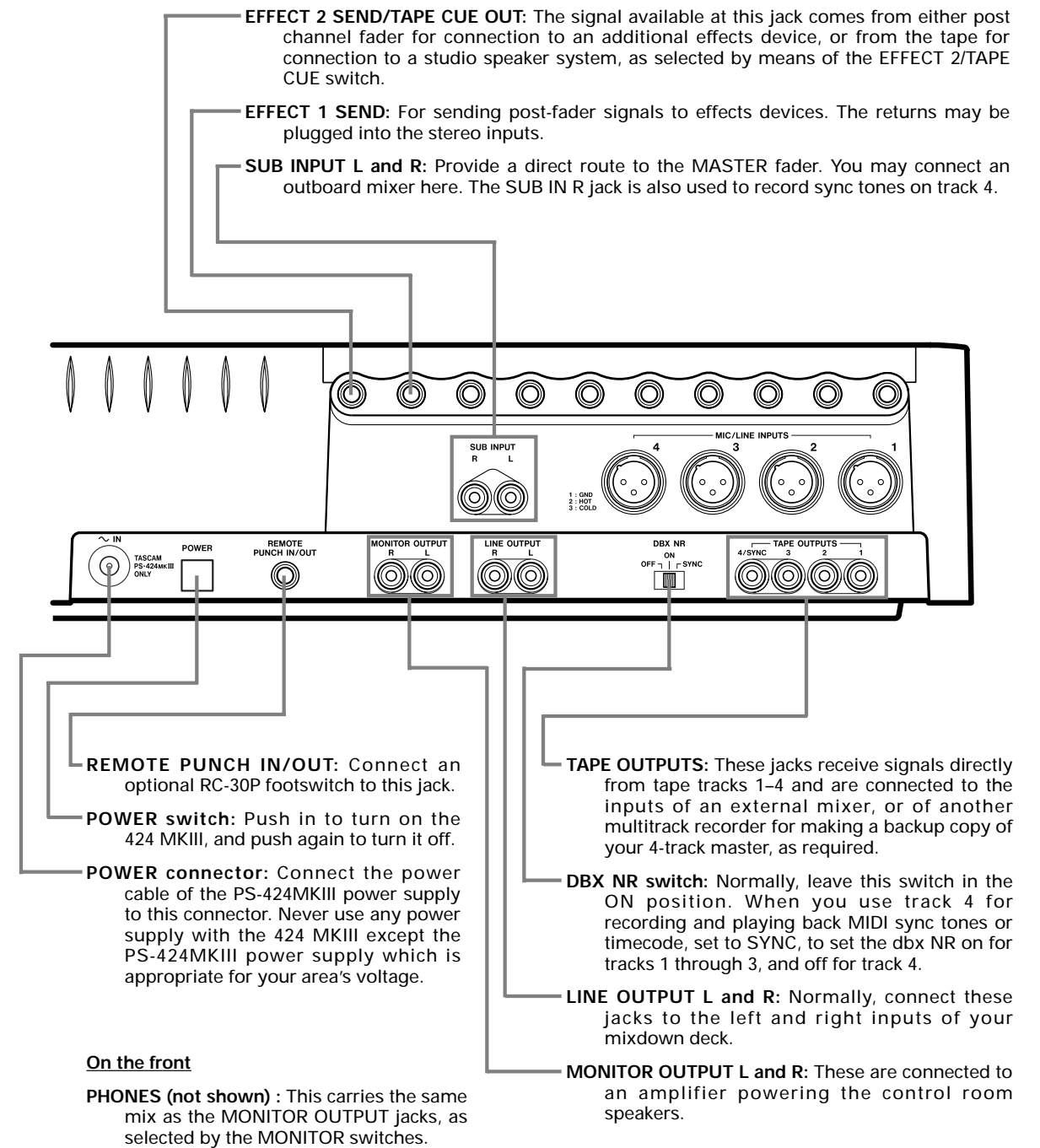

# Step-By-Step-Operations Guide

Let's try the 424 MKIII mixer

To learn how the mixer works, first you need to plug a signal source into one of the 1-8 jacks located at upper top of the unit, in your easy reach.

As an example, we'll use a microphone as the source.

Notes to be read prior to making connections

- Although both XLR-type and 1/4" phone jacks are provided for connection to each of channels 1-4, don't use both jacks on the same channel at the same time.
- Turn all the TRIM and other level controls all the way to the left.
- Turn the EQ controls to their center "flat" position; bring all the faders down; and set all the switches to OFF.

## Input connections



## Powering on



## Headphone connection

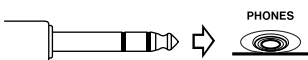

## Routing inputs

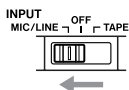

1. Have to hand a dynamic microphone and a set of stereo headphones.
2. Plug the 1/4" plug on your microphone cable into the leftmost MIC/LINE IN jack for channel 1.
3. Turn the 424 MKIII on. The TASCAM logo appears in the display. (The POWER switch is located on the back, beside the power cable.)
4. Plug your headphones into the front PHONES jack, so you can hear the input signal going to the mixer section of the 424 MKIII.
5. Set the channel 1 INPUT select switch to the left (MIC/LINE) position.

## Panning

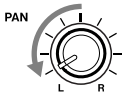

## Channel level

## Master level

## Monitor selection

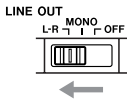

## TRIM adjustment

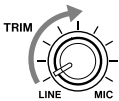

## Listening level

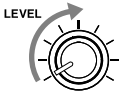

6. Turn the channel 1 PAN control all the way to the left.

7. Raise the channel fader to "7" on the scale.

8. Raise the MASTER fader to "7".

9. Set the MONITOR SELECT LINE OUT switch to the left (L-R) position.

10. While speaking into the microphone, turn the TRIM control in channel 1 to the right/MIC until the monitor level meter reads around "0" in average.

11. Slowly turn the MONITOR LEVEL control to the right. You will hear your voice in the left side of the headphones.

When using a line level source (such as electronic instruments) instead of the mic, the TRIM does not need to be turned up very far, if at all.

## How to record on track 1

## Loading a cassette

## Getting past the leader tape

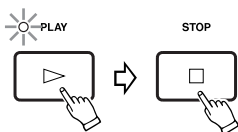

As a trial, let's record your voice on tape.

1. Have in hand a new cassette tape (Type II, C-90 length or shorter).
2. Open the cassette door using the tab on the right of the door. Insert the cassette tape, and close the cassette door.
3. Press PLAY and allow the tape to run for about 5 seconds. This will run the tape leader onto the takeup reel, and put the beginning of the tape in front of the heads.

## Resetting the counter



## Selecting tracks

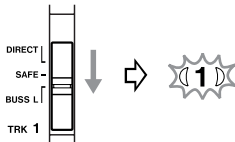

## Mic level adjustment



## Beginning to record

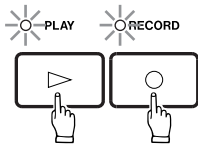

## Stopping recording

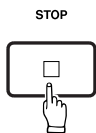

## Putting track into "Safe"

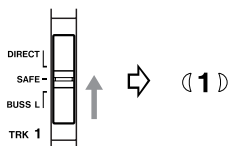

4. Press the COUNTER RESET switch, so you can use the RTZ (Return-To-Zero) function to get back to this point.

5. Set the RECORD FUNCTION switch for TRK 1 to its BUSS L position. The REC "1" indicator will start blinking in the display window, indicating track 1 is in Record Ready mode.

6. Speak into the mic. You will see meter 1 move. If no level or too low a level is shown, continue to speak into the mic and slowly turn the channel 1 TRIM control to the right/MIC until the meter peaks at no more than "+6".

7. Hold RECORD and press PLAY to initiate recording. The REC "1" indicator that was blinking in the meter will turn on solid, indicating track 1 is in Record mode.

8. Speak into the mic.

9. Press STOP to stop the tape and finish recording.

10. The REC "1" indicator in the meter should now be blinking as before. Set the RECORD FUNCTION switch for TRK1 to its SAFE position.

## Track 1 playback through TAPE CUE

### Switching TAPE CUE on



### Monitor selection

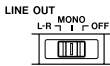

### Locating tape to zero



### Begin to play



### Listening level adjustment



### Routing tape signals to TAPE CUE



### Stop play

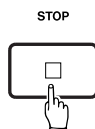

1. Set the EFFECT 2/TAPE CUE selection switch located below the LEVEL control to the right/TAPE CUE position.
2. Slide the MONITOR SELECT LINE OUT switch to the center MONO position.
3. Press the RTZ key. The tape will rewind, automatically stopping at the zero counter point.
4. Press PLAY.
5. Turn the MONITOR LEVEL control up or down to the desired listening level.
6. Locate the EFFECT 2/TAPE CUE level control on channel 1 and slowly turn it to the right. You'll hear, in center mono, what you have recorded on track 1.
7. Press STOP to stop play.



## How to make an overdub on track 2

### Routing input

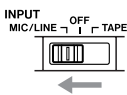

### Panning

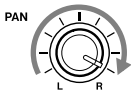

### Channel 1 level

### Master level

### Monitor selection



### Locating tape to zero



### Track selection

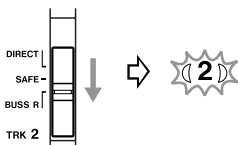

### Record level adjustment (TRIM)

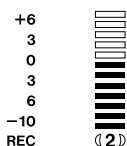

Overdubbing entails recording one or more additional tracks on the same tape, while listening to previously recorded tracks using TAPE CUE.

Leave the microphone connected to the channel 1 input. There is no need to repatch it to channel 2 to record on track 2. You can send any mixer input to any track of the recorder through the combination use of PAN and RECORD FUNCTION.

1. Set the channel 1 INPUT selection switch to the left (MIC/LINE) position.
2. Turn the channel 1 PAN control all the way to the right (R) position.
3. Bring the channel 1 fader to 7.
4. Bring the MASTER fader to 7.
5. Make sure the MONITOR SELECT LINE OUT switch is still in the MONO position.
6. Press the RTZ key, so the tape will rewind to the beginning of the track 1 recording.
7. Set the TRK 2 RECORD FUNCTION switch to its BUSS R position. The REC 2 indicator will start blinking in the meter.
8. Speak into the mic to check to see meter 2 move. If no level or too low a level is shown, continue to speak into the mic and slowly turn the channel 1 TRIM control to the right until the meter peaks at no more than +6.

## Begin to record

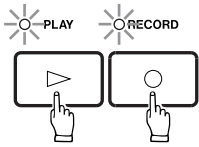

## Monitoring input/tape

## Stop recording

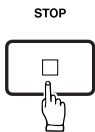

## Putting track into "Safe"

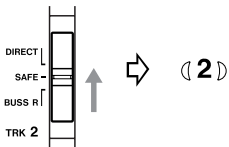

9. Hold RECORD and press PLAY to initiate recording. The REC "2" indicator that was blinking will turn on solid, indicating track 2 is now being recorded.

10. You will hear track 1 play, together with the new signal going to track 2, in the headphones.

**NOTE:** Adjust only the TAPE CUE control of channel 1 if you need to change the balance between the old and new tracks in your headphones. Leave the channel fader and TRIM and the MASTER fader alone, because they control the level being recorded.

11. Press STOP to stop recording.

12. The REC 2 indicator in the meter should now be blinking as before. Set TRK 2 RECORD FUNCTION switch back to its SAFE position and the indicator will turn off.

## How to record tracks 3 and 4

Tracks 3 and 4 can be recorded using almost the same procedure just shown for tracks 1 and 2. Just use the applicable RECORD FUNCTION switches, and the PAN controls should be rotated to the LEFT for recording on Track 3 and to the RIGHT for Track 4.

## How to record many sources onto a single track

In the first example, we recorded one source onto one track at a time for simplicity. But the mixer of the Portastudio 424 MKIII can take multiple channels and mix them onto a single track. To do this :

- Set the PAN control of each channel to the same setting, for example :

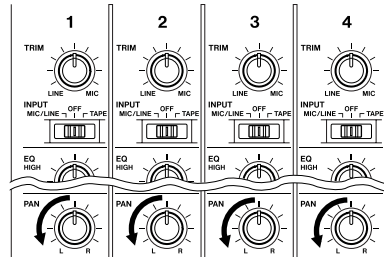

In this example, all instruments plugged into channels 1-4 will be recorded onto Track 1 or 3.

- Lower the MASTER fader to make overall level adjustments once you have each channel's TRIM and fader level set.
- Make sure the INPUT switch of every channel you want to record is set to MIC/LINE.
- *You can't record channels 7 and 8 onto a single track.*

### How to record a mix onto two tracks simultaneously

If you want to record multiple sources onto two tracks, you use the channel PAN controls to send them to LEFT or RIGHT (or anywhere in between, if you're making a stereo mix). The track RECORD FUNCTION switches choose what track the Left and Right mixes will be recorded on. Note that in this method, the mixer channel number has nothing to do with what track the instrument winds up on. Any mixer channel can be panned to any track.

These mixer channels are being sent to the LEFT, for recording on either Track 1 or Track 3.

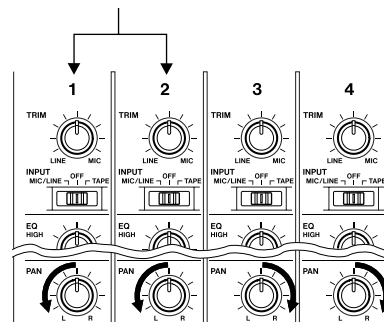

These mixer channels are being sent to the RIGHT, for recording on either Track 2 or Track 4.

- Set the MONITOR SELECT LINE OUT switch to L-R or MONO, and set the EFFECT 2/TAPE CUE switch to TAPE CUE if you need to hear tape tracks or MIDI virtual tracks.

Recording is the same procedure as for one track. In the example above, set both the TRK 3 and TRK 4 RECORD FUNCTION switches to BUSS to record on tracks 3 and 4 simultaneously.

Restrictions : The 424 MKIII mixer section has only two main mixes, Left and Right. For this reason, *you can record only two tracks at once while you're recording a mix of instruments* (for example, two instruments on track 1, three instruments on track 2). Also, *you can record a mix only on combinations or even/odd numbered tracks* (1 & 2, 1 & 4, 2 & 3 etc.). If the TRK 1 and TRK 3 RECORD FUNCTION switches are set to BUSS, the two tracks will both record the same mix.

**Recording the stereo channels (5-6 and 7-8)** : Channels 5 and 6 can be used to add additional signals to the L and R mixes. The input for these channels can be odd-numbered inputs 1 through 5 (channel 5) and even-numbered inputs 2 through 6 (channel 6).

Note that if one of the inputs 1 through 4 is selected for use with its appropriately-numbered channel, as well as with channel 5 or 6, the signal level will be doubled, as it is being mixed through two channels together.

Use the stereo channels 7 and 8 to add additional signal sources to the mix. These channels are automatically panned left and right respectively, so you may want to use them with a pre-panned source, such as the stereo outputs of a multi-timbral synthesizer, or a stereo effects unit.

#### Recording on more than two tracks simultaneously : DIRECT

It is possible to record on three or four tracks at the same time by using the DIRECT position of the RECORD FUNCTION switches. In Direct recording, each track gets its signal from a single mixer channel only — Track 3 from channel 3, etc.

- When using DIRECT, the MASTER fader has no effect on the record level. It only affects the level going to the headphones/monitor speakers. Use the CHANNEL FADER only to set record levels.
- Even when using DIRECT, a channel still goes to the Left/Right mix. If you record another track with BUSS L or BUSS R at the same time, you must check your PAN settings. For example, you can record a vocal DIRECT onto Track 3, and record multiple instruments on Track 1 via BUSS L at the same time. But Channel 3's PAN control must be turned hard right, otherwise you'll wind up with vocals "bleeding through" onto Track 1's instruments.
- DIRECT can be used anytime you want to record a single channel to a single track.

## How to mix down

### Connections

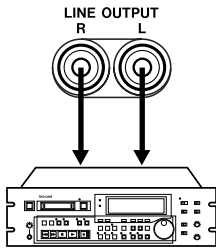

### Master level

### Monitor source



### Routing inputs

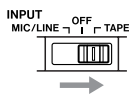

### Playback level

When the 4 tracks are all recorded, the final step is mixing them into a standard stereo format. This procedure is known as Remixing or Mixing down. During this procedure the tracks are blended together and balanced to create the desired sound.

1. Connect the LINE OUTPUT L jack of the 424 MKIII to the left line input of the mixdown deck, and the LINE OUTPUT R jack to the right line input.
2. Raise the MASTER fader to the shaded area between 7 and 8.
3. Set the MONITOR SELECT LINE OUT switch to the L-R position.
4. Set all the INPUT select switches on the input channels to the right TAPE position.
5. Press PLAY and, while listening to the tape play, tentatively set the channel faders.
6. Adjust the PAN controls to set each track's left-to-right position for the desired stereo image. You may also want to use the EQ controls to adjust the individual tracks for the desired tonality. (For using effects, see page 35.)
7. Using the MASTER fader, adjust the overall playback level so the monitor level meter averages around "0" and peaks below "+6".

---

**Review**

8. When the signal balance, level, and tonality sound right, rewind the tape, and press PLAY again to check the result.
9. Rewind the multitrack tape again. Put a blank tape in the mixdown deck and let it play for 5 seconds, then stop it and reset the mixdown deck's counter to zero.
10. Press PLAY on the 424 MKIII.

**Record level**

11. Put the mixdown deck into its "Record Ready" mode, and adjust its input level controls for the desired record level.
12. Rewind the multitrack tape to the beginning of the recording.
13. Put the mixdown deck into Record mode then press PLAY on the 424 MKIII.
14. When recording is done, stop both machines, rewind the mixdown tape and listen to it.

If the mixdown tape does not sound right, make the necessary corrections and re-do from the beginning.

**Using channels 5 and 6 with alternative inputs at mixdown:**

When channels 1 through 4 are being used to replay previously-recorded tape tracks, channels 5 and 6 can be used to add signals received at the MIC/LINE INPUTS of channels 1-4.

Set the INPUT switch for channel 5 to 1 or 3 or 5, and the INPUT switch for channel 6 to 2 or 4 or 6.

These signals will appear in the final stereo mix. Use the PAN control to position them in the desired stereo position.

# Using Memory Location Points

## Loading MEMO points

### MEMO 1



### MEMO 2



### Establishing new MEMOs

### Recalculation of MEMOs

### Checking MEMO points



### Erasing

Two autolocation points can be established in the 424 MKIII's memory system.

At the desired moment, hold the MEMO IN key and press the LOC 1 key. The MEMO 1 indicator will turn on, showing that the current tape location is loaded into that register.

Similarly, if you hold MEMO IN and press LOC 2, the current tape location is loaded as memory point 2 into that register.

Each time LOC 1 or 2 is pressed while MEMO IN is held down, a new memory point is established, and the previous memory point is erased.

MEMO points can't be entered while the tape is locating to either MEMO point or during REPEAT.

If the COUNTER RESET button is pressed, both MEMO points are automatically recalculated, so they stay the same relative to their original tape positions.

When the tape is stopped, hold down the desired LOC key (for 0.5 second or more). The content of the corresponding MEMO register will be displayed in the counter window.

**Remember :** If you don't hold down but just hit the LOC key, the tape is autolocated to the corresponding MEMO point.

Both MEMO points are erased when the cassette is taken out from the compartment or the power is turned off.

## Locating the tape

### To zero



Press the RTZ key to fast wind the tape to the counter zero point.

If you press COUNTER RESET during the RTZ process, the tape counter is reset to 0000 and the tape stops.

### To MEMO 1



Hit the LOC 1 key to fast wind the tape to the MEMO 1 point.

**Note :** Only touch the LOC key. If you hold it down for 0.5 second or more, autolocation does not start and only the tape counter shows the location point.

### To MEMO 2



Hit the LOC 2 key to fast wind the tape to the MEMO 2 point.

**Note :** For the deck to autolocate, the current point must be 0003 or more higher or lower than the memo point. A shorter distance only causes the MEMO 1 (or 2) indicator to flash upon hitting the LOC 1 (or 2) key.

### Auto play

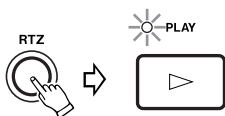

If PLAY is pressed after RTZ, LOC 1 or LOC 2, the tape will automatically start playing when the location point is reached.



# Repeat Play

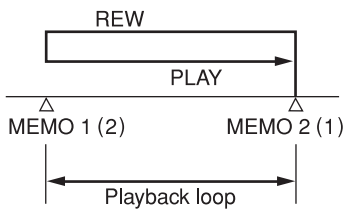

## Operating procedure

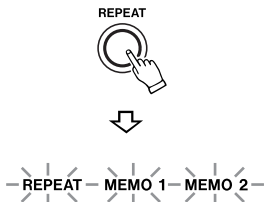

## To interrupt REPEAT sequence



## Note 1

## Note 2

The REPEAT function provides a "Playback Loop" or "Block Repeat" between the two programmed MEMO points. The 424 MKIII understands the lower MEMO point as the start point of the loop, and the higher point as the end.

1. Use MEMO IN and LOC 1 and LOC 2 (as explained above) to establish the beginning and the end of loop.
2. Press the REPEAT key. The tape will fast wind to the lower MEMO point.
3. As soon as that location is reached, the tape will automatically start playing to the higher MEMO location.
4. When the tape reaches the end of the loop, it will automatically rewind to the lower MEMO location and start over.

Press any transport keys (except Play). The function pressed will be activated. If the tape is wound outside the repeat loop points, the REPEAT LED that was on solid will start blinking.

To resume the REPEAT sequence –;

- Press the LOC 1 or LOC 2 key.

OR

- If you are now within the loop or shortly behind the lower MEMO point, press PLAY.

Repeat Play does not work while the 424 MKIII is in Record mode (REC LED is blinking or lights on solid).

A space of 0003 or more (as controlled on the tape counter) is required between two memo points. If you create a smaller loop and press REPEAT, the REPEAT indicator does not light up in the display and both the MEMO 1 and MEMO 2 indicators flash, showing that the loop cannot be played.

# PUNCH-IN or INSERT Recording

---

Preliminary

"Punching in" or "insert recording" is recording over a small section of previously recorded track to correct or improve a performance, while keeping the rest of the track intact. The mixer settings should be exactly the same as they were during the original recording.

In the following, we'll use track 2 as the punch-in track as an example.

1. As the punch-in track is track 2 in our example, your input must be sent to the stereo right bus. To do so, rotate the PAN control of the channel into which your source instrument is plugged all the way to the right.
2. TAPE CUE signal path is used to hear the tape, so set the EFFECT 2/TAPE CUE select switch (located below the MONITOR LEVEL control) to the TAPE CUE position and set the EFFECT/CUE monitor switch to EFFECT 2/CUE.
3. To hear the instrument, set the MONITOR SELECT LINE OUT switch to the MONO position.
4. Press PLAY to play the tape, adjust the TAPE CUE control on channel 2 until the MONITOR level meters read a maximum of from 0 to +3, and adjust the MONITOR LEVEL control for the desired headphone listening level.
5. Play the instrument. You'll hear it together with the tape signals through the headphones. Stop the tape, and you hear only the instrument being played.
6. Set the TRK 2 RECORD FUNCTION switch to BUSS R. The REC 2 indicator will start blinking in the display window, and meter 2 will show your instrument's output level. Adjust the channel and MASTER faders for the proper recording level.

## Selecting in and out points

For both musical and technical reasons, when punching in or out of a track, you must select points that are "in the points clear", i.e., in pauses between phrases or notes. Sound seems unnatural and inserts are noticeable if a new note is recorded before the old one has ended, or a note is held as you punch in or out. Making smooth inserts requires practice. Spacing between the erase and record heads requires that you anticipate in/out points by a fraction of a second for extremely tight cues. Use the following procedures with the REHEARSAL switch on.

## Rehearsal and Auto In/Out Procedures

### Rehearsing Punch-in (Insert) recording

### Storing the punch-in and out points into memory

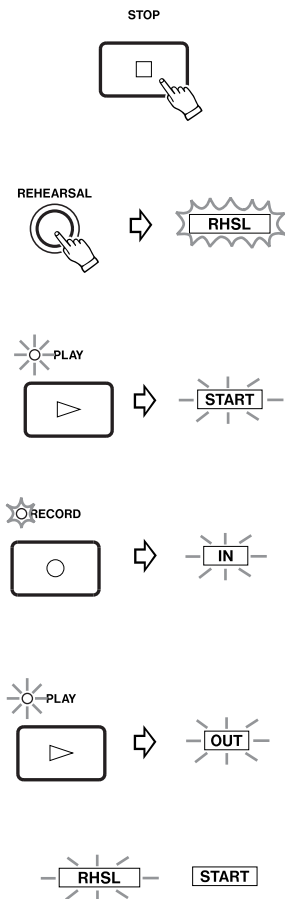

### Rehearsal



You can rehearse your punch-in as many times needed without affecting the existing recording. During rehearsal, what you hear in the monitor mix and read on the level meters will be the same as during recording, but signal won't be recorded on tape.

1. Cue the tape up a few seconds before you reach the expected punch-in point.
2. Press the REHEARSAL switch. The "RHSL" indicator will start blinking in the display.
3. Press PLAY to start playing ("preroll"). The "START" indicator will glow on the display. The counter readout at which the key was pressed is stored as the START point. The MEMO 1 or 2 indicator turns off (if it was lit).
4. When you reach JUST BEFORE the error, press RECORD to start recording (punch in). The "IN" indicator will glow on the display and an LED will start flashing above the RECORD button. The counter readout at which the key was pressed is stored as the PUNCH-IN point.
5. When the tape reaches the expected punch-out point, press PLAY. The "OUT" indicator will turn on, and the "IN" indicator and the LED above the RECORD button will turn off. The counter readout at which the key was pressed is stored as the PUNCH-OUT point.
6. The tape will play for about 3 seconds ("postroll"), then will automatically rewind, stopping at the START point. The "RHSL" indicator that was blinking will glow solid in the display.
7. Press PLAY (or REPEAT if you want to practice the performance over and over again, continuously). When the tape reaches the preset punch-in point, the monitor will switch from tape to "live" instrument on the punch-in track (in our example, on track 2).

The RECORD LED will blink to indicate that you are "rehearsing" punch-in recording, not actually recording.



When the tape reaches the preset punch-out point, you will be able to hear the old material existing on track 2, letting you check that the new material is smoothly followed by the old one. The RECORD LED will turn off, indicating that the "dry-run" record is over.

After 3 seconds of play ("postroll") the tape will automatically rewind, stopping at the START point, so you can again go through the rehearsal procedure.

- To change the punch-in and out points, press CLEAR, and restart from the beginning.
- If you want to quit Rehearsal mode for any reason, press CLEAR. "RHSL" goes out and the start, punch-in and out points are cleared from memory.
- Practice the performance until you are sure that you will get it right when actually recording. Remember, punching-in over existing material erases the original signal.
- When the REHEARSAL key is pressed during playback, the counter readout at which the key is pressed is stored as the START point.
- You can store the Punch-In/Out or Rehearsal point also using the optional remote footswitch (RC-30P).

Suggestion: During the punch-in setting or the rehearsal process, if you press the footswitch after STOP, the tape will rewind to your START point.

- Rehearsal function is not available while the 424 MKIII is in the locate, repeat or record mode.
- Locate or repeat function is not available while storing Punch-In/Out points in memory.
- After the Punch-In/Out points have been stored in memory, the 424 MKIII cannot enter the record mode (whereby RECORD LED blinks or glows).
- If you press any of the transport keys during storage of the Rehearsal (Punch-In/Out) points, the 424 MKIII will start operation corresponding to the key pressed. However, only when the REW key is pressed, the tape will rewind, stopping at that Start point.

### Actual Auto Punch In/Out

Once you're sure your performance and the in/out points selected are correct, you're ready to actually record the insert using the Auto Punch-In/Out feature.

Before proceeding to the next step, #8, check to see that the RHSL indicator is on solid in the display, showing that your punch-in and out points are in memory, and that all REC indicators beneath the meters are off (except the one for the punch-in track), showing that all non-punch-in tracks are in Safe mode.

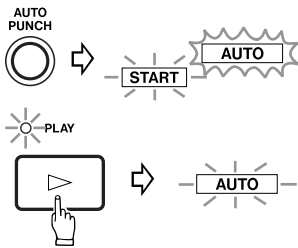

### Auto Review



### Manual Punch-in

### Punching-in/out with RECORD



8. Press the AUTO PUNCH switch. "RHSL" will turn off and "AUTO" will start blinking in the display.

9. Press PLAY.

What you have anticipated in REHEARSAL will automatically occur in sequence: preroll, punch in, punch out, postroll, rewind, and stop.

"AUTO" will be solidly displayed when the 424 MKIII punches out of record.

10. Press PLAY (or the optional footswitch). The tape will play the entire length of insert and rewind to the START point.

After completing auto review if you want to re-do the auto punch-in and out using the same settings, press the AUTO PUNCH switch once more and "AUTO", which was lit steadily, starts flashing as before, showing that the auto punch-in process will restart when pressing PLAY.

- **To Disable AUTO PUNCH Mode**, press CLEAR. The memory points will be cleared and "AUTO" will turn off in the display.

The 424 MKIII lets you manually punch in, too. There are 2 ways to initiate the punch-in recording. The first is with the transport RECORD button, and the second is with the optional footswitch.

We always use track 2 as the punch-in track in the following example.

Perform the "Preliminary" on page 28, if you haven't yet done so.

1. Check to see that the REC 2 indicator is blinking showing track 2 is in Rec Ready mode. Locate the tape a little behind the expected punch-in point. Then press PLAY.

2. When you reach JUST BEFORE the error, press RECORD. The REC 2 indicator that was blinking will be solidly displayed and track 2 enters Record mode.

3. To punch-out of record, press PLAY. The REC 2 indicator that was solidly displayed again blinks to indicate that recording is over.

4. To stop the tape, press STOP.

---

### Using the remote footswitch (RC-30P)

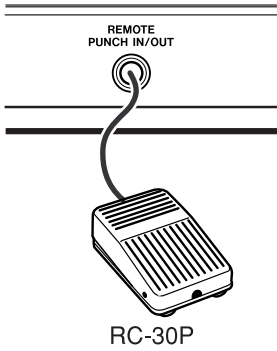

If you are recording alone and are too busy playing an instrument to push the switches, the optional remote footswitch really comes in handy.

1. Plug the RC-30P into the REMOTE PUNCH IN/OUT jack on the rear panel of the 424 MKIII.
2. Check that the REC 2 indicator is blinking, and locate the tape to a point a little before the error, then press PLAY.
3. When you reach JUST BEFORE the error, press the footswitch. This has the same effect as pressing RECORD, and the REC 2 indicator that was blinking will glow steadily to indicate track 2 is in Record mode.
4. To punch-out of record, press the footswitch again. It has the same effect as pressing PLAY. The REC 2 indicator will start blinking again.
5. To stop the tape press STOP.

## Bouncing Tracks (Ping-Pong)

The recording capability of the PORTASTUDIO 424 MKIII is not limited to four tracks. You can "bounce" or combine tracks you have recorded to an empty track, and then replace the original tracks with new material. A bounce is like a mixdown, except you are recording to one of the tracks of the 424 MKIII instead of to an external recorder. The following diagrams depict the process.

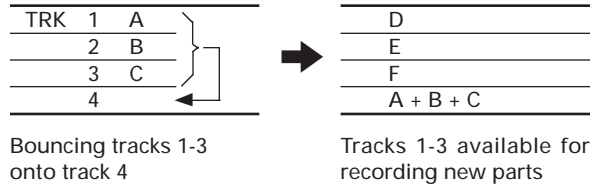

During a bounce you can add live sources along with the prerecorded tracks, using the "empty" mixer channels not being used for tape playback. This gives you even more ways to add layers to a composition. For example, you can bounce tracks 1-3 along with another "live" part onto track 4, for a total of four parts on one track.

### Ping-pong procedure

In this example, we will combine material from tracks 1-3 onto track 4.

1. On channels 1-3, make the following settings :
  - INPUT to TAPE,
  - PAN all the way to R, and
  - Input fader to the shaded zone (7-8 on the scale).
2. Push the MASTER fader to the shaded zone.
3. Set the MONITOR SELECT LINE OUT switch to the MONO position.
4. Set the RECORD FUNCTION switch for track 4 to BUSS R. The REC 4 indicator will start blinking in the meter window, indicating the track is in Rec Ready mode.
5. Press PLAY. The tape will start playing.

- 
6. Use channel faders 1 through 3 to make any necessary level adjustments. You may want to repeat this step several times to get the balance correct.
  7. When the balance is right and the level is peaking at no more than +6 on the track 4 meter, stop and rewind the tape to the beginning of the track.
  8. Hold RECORD and press PLAY. The REC 4 indicator that was blinking will turn on solid and track 4 will record a copy of what is on tracks 1-3.
  9. You'll hear the mix being recorded on track 4 in the headphones.
  10. Once the recording is done, press STOP.
  11. The REC 4 indicator will now be blinking as before. Turn that off by setting the RECORD FUNCTION switch for track 4 to SAFE.

When bouncing tracks, remember that live material can be added from channels 5 and 6, as well as from 7-8. Channels 5 and 6 can use the signal sources connected to inputs 1 through 4, using the INPUT switches for channels 5 and 6.



# Using Effects With the PORTASTUDIO 424 MKIII

---

Effects and signal processing are areas where you can really start to have fun customizing your sound, and develop your own unique recording style. Because there are so many possibilities, it also can be confusing. There are many different effect units on the market, all with different controls, types of inputs and outputs, and other characteristics. Read the manual of your effects device, and the following sections to get the complete story of what's possible for your particular situation.

- 1. In-line processing:** The processing that's easiest to understand doesn't involve the 424 MKIII directly at all. You can plug your instrument directly into the input of the effect device, and plug the output of the device directly into a line input of the 424 MKIII. The whole signal gets processed (flanged, doubled, limited, delayed etc.), and only one instrument can use that processor. Effect pedals for guitar are typically used this way. To get a mix of processed ("wet") and original ("dry") signal, the unit must have its own MIX or BALANCE control.
- 2. Send/return mix processing:** This is the most common method of effect processing, especially for reverb and delay. It allows a number of different channels to use the same effect, while allowing you to control how much effect is mixed with each channel. Each of the 4 mixer channels can send signals to the EFFECT SEND 1 or 2 outputs on the upper top panel. These outputs can then be connected to the input of effect devices. The processed signals from the devices come back into the mix via the STEREO INPUTS. Finally, the effect is mixed onto the stereo left or right buss with the ASSIGN switch on the stereo channels (7-8). This whole path—from the EFFECT SENDS to the reverb and back into STEREO INPUTS — is called an effects loop. The EFFECT 1 and 2 controls determine how much signal goes to the reverb unit; the LEVEL control on the stereo channels determine how much returns from the reverb unit. In this method, the stereo inputs function as effect returns.

## Setting effect send levels

The goal is not to distort the device, while staying above the noise that effect units generate. To get the best signal-to-noise from most effects units, you should send it as strong a signal as you can. With a properly set input signal in the 424 MKIII, the channel EFFECT send set to about 2 o'clock position (for EFFECT 1 or EFFECT 2 feed), you should get a fairly loud signal from the EFFECT SEND jacks.

If your effects device has an input level control of its own, it should be set so the meter or signal light of the effects device is just under the overload point on peak signals. When you want to hear less effect overall, turn down the return LEVEL control on the stereo channels.

## Setting the output level of effect devices

If the effect send level has been set properly, in most cases the output level of the effect unit should be set as high as possible without clipping (distorting) the STEREO INPUTS of the 424 MKIII, but low enough so that you have a reasonable range of control. If you can get the effect sound you want with the return LEVEL control in the 12 to 2 o'clock range, you're in the ballpark. If, on the other hand, very small settings of the Effects Return still give you a mix drowning in effects, turn down the output level of your effect device.

Some effect units have rear panel switches setting input and output level ranges between "+4" and "-20 dB". In this case, try setting the input to -20 (high sensitivity) and the output to +4 (full output level).

## Setting the mix/balance control on effect devices

When it's being used in a send-return mix, set the mix/balance of your effect device all the way to "wet" or full processing with no direct original signal. In send/receive processing, the dry signal goes down the 424 MKIII's channel fader to be mixed with the effect return signal on the stereo mix. Therefore, you don't need any "dry" signal coming to the effects return. The mix/balance control is set toward "dry" only when you're using the effects device as an in-line processor.

## How to Connect Your Effects Devices

There is no absolute "right" or "wrong" way to do this—there are several ways, each with its own consequences.

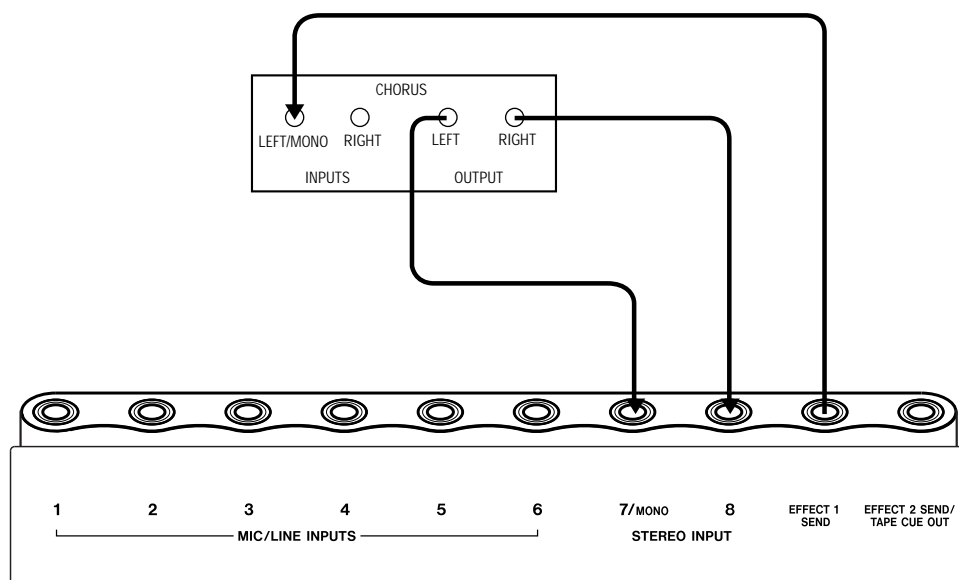

**Mono returns:** A special feature of the STEREO INPUT allows continuously variable control between left and right if desired: a mono effect connected to 7/MONO will go to 7-8 LEVEL control if nothing is plugged into jack 8.

**Patching effects to an input channel:** There's no law that says the output of an effects device must be plugged into a STEREO INPUT, either. They can also be plugged into LINE INPUTS just like any other source, if you are cautious about one thing: make sure the EFFECT controls of those channels are set to the off position (turned all the way to the left). Otherwise, you will be sending the output of the effect device back to itself, which is a kind of feedback. If the effect device is a digital delay, feedback has the same effect as a regeneration (number of echoes) control. An advantage of returning effects to a main channel is that you can EQ the effect return.

**To record reverb onto a track :** Switch the ASSIGN switch to L-R, and adjust the controls for the sound you want. Remember that stereo signals must be recorded onto two tracks to keep their "stereo" effect.

**To hear reverb in the headphones but not record the reverb :** Set the ASSIGN switch on the stereo channel being used for returning effects to the right/MON position, turning up the LEVEL control on the stereo channel in use.

## Syncing MIDI-Tape – Using the TASCAM MTS-30

MIDI clocks are themselves a computer type digital language and cannot be recorded on analog tape; it is necessary to convert them to recordable FSK (Frequency Shift Keying) signals using an appropriate converter, such as the MTS-30.

The MTS-30 is not a mere MIDI-FSK converter but translates MIDI clocks into an FSK sync signal containing score "bar" information or "Song Position Pointer", allowing the associated MIDI equipment to stay in sync and follow the tape no matter where you move the tape within a given song. The maximum stability or resolution of the synchronization is ensured by a TASCAM-exclusive error correction circuit in the MTS-30.

1. Connect the TAPE OUT of the MTS-30 to the SUB IN "R" of the 424 MKIII, and the TAPE OUT 4 of the 424 MKIII to the TAPE IN of the MTS-30.
  2. Set the TRK 4 RECORD FUNCTION switch to BUSS R.
  3. Locate the DBX NR switch on the back panel and set it to the SYNC position. This defeats the dbx encode/decode for track 4 only.
- When recording FSK signal, adjust the MASTER fader of the 424 MKIII to get a reading on the track 4 meter of from -10 to 0 dB.

We suggest that you input the "virtual" tracks from the MIDI system to STEREO INPUTS 7 and 8. Set the ASSIGN switch of these inputs to MON while recording, and to L-R position on mixdown.

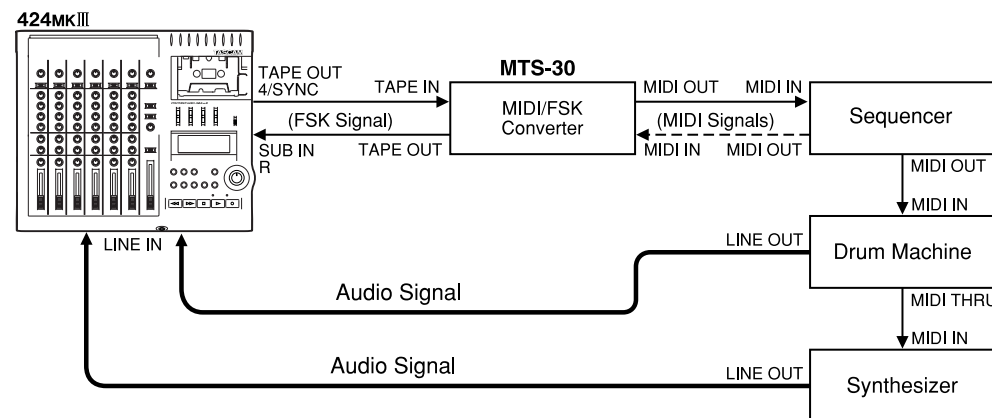

## Troubleshooting

Problem	Possible Cause
Playback sounds dull	Dirty heads
Playback level is low	Dirty heads
Transport keys not effective	Power turned off, or tape not loaded
No tape motion	PAUSE pressed
No recording	RECORD FUNCTION set to SAFE, cassette tab broken, or REHEARSAL engaged
Wrong tracks recorded	PAN improperly set
Incorrect playback pitch	PITCH CONTROL set to a different position than during recording
Feedback occurs during ping-pong recording	Level is too high or EQ HIGH is excessively boosted

Problem	Solution
Old tracks are always recorded along with new material.	Use the TAPE CUE section instead of the main mixer for monitoring previous tracks.
Recording is noisy.	Make sure all mixer channel INPUT switches are in the OFF position except ones you are using. Also, increase the volume faders of the instruments themselves — the 424 MKIII channel and master faders should not have to be "full up" at any time.
Incorrect tape sync.	Try re-recording sync tones by adjusting the MASTER fader between -10 to 0 dB on the track 4 meter.

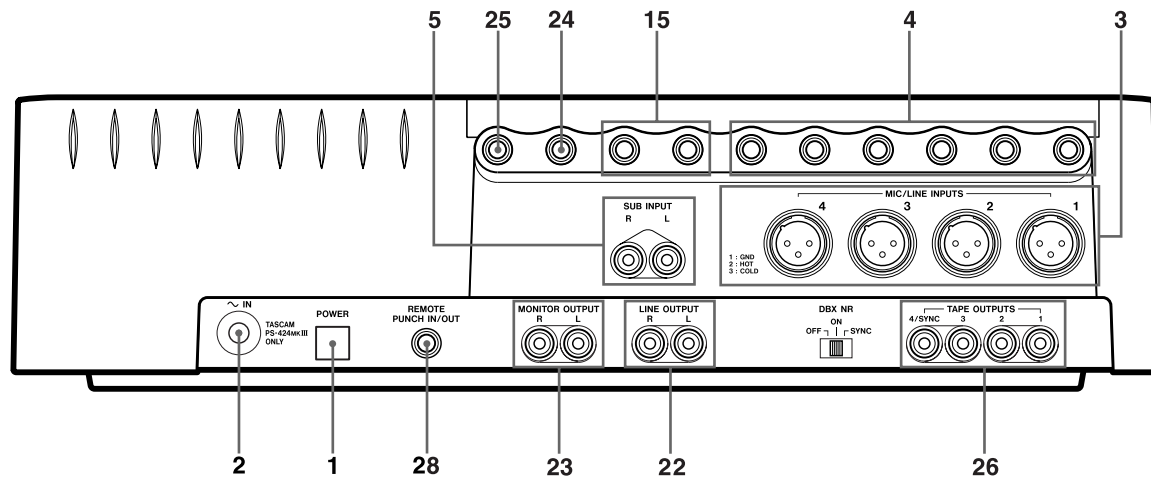

## 424 MKIII MIXER

- POWER switch (on the rear panel):** Turns the 424 MKIII on and off.
- Power connector:** Connect the power adaptor for the 424 MKIII to this connector. It is important that you use only a power adaptor specially designed for the 424 MKIII which is designed for use with the voltage in your area.

### Input Section

- MIC/LINE INPUTS jacks, Balanced (Channels 1-4):** The 3-contact XLR-type connector accepts balanced microphone signals ranging from  $-60$  dBV (1 mV) to  $-20$  dBV (100 mV), depending on the setting of the TRIM control (#6).
- MIC/LINE INPUTS jacks, Unbalanced (Channels 1-4):** This 1/4" jack accepts unbalanced signals ranging from  $-50$  dBV (3 mV) to  $-10$  dBV (0.3 V), depending on the setting of the TRIM control (#6).

**NOTE**

■ DO NOT use both the XLR-type and 1/4" phone jacks on the same channel at the same time.

- SUB INPUT L and R jacks:** These jacks are for cascade connection of an outboard mixer, etc. The signal input to these jacks is sent to the MASTER fader. Nominal input level is  $-10$  dBV (0.3 V).

The SUB IN R jack is also used to accept FSK-converted MIDI sync signals from devices such as the optional TASCAM MIDI-Tape Synchronizer MTS-30.

- TRIM controls:** This is used to set preamplification level on the MIC/LINE INPUTS. When TRIM is turned all the way to the left (LINE position), the preamplifier gain is low, allowing the jack to accept line level sources such as electronic instruments. As you turn TRIM up, the preamplifier gain increases, and when you turn TRIM full clockwise (MIC position), the nominal input sensitivity increases to  $-50$  dBV (3 mV) for 1/4" phone jack, and to  $-60$  dBV (1 mV) for XLR-type jack.

- INPUT select switches:**

### (channels 1-4)

This is used to control what the source of the channel is:

The left position (MIC/LINE) is used when recording microphones/instruments (in tracking or overdubbing).

The center position (OFF) is used to shut off the channel.

The right position (TAPE) is used during mixdown or bouncing tracks.

### (channels 5 and 6)

This is used to control the source of these channels. Channel 5 can accept the signals from equipment connected to odd-numbered inputs 1, 3 and 5, and channel 6 uses the even-numbered inputs in the same way. Slide the switch to the appropriate number to send the signal from the appropriately-numbered input to the channel.

Note that if signals are sent through more than one channel at the same time (e.g. through channel 1 and 5), the level of these signals will be doubled. You should allow for this when mixing.

- EQ HIGH:** This controls the tonality of the high or "treble" frequencies. Turn it to the right to boost the signal's high frequency content emphasizing brilliance or brightness. Turn it to the left to cut the high frequency content, if the signal sounds too harsh or shrill. The EQ shelving point is 10 kHz.

- EQ MID:** The upper knob changes the center frequency of the MID equalizer from 250 Hz to 5 kHz. The lower knob controls how much cut or boost is applied to the band chosen by the upper knob. Turning the lower knob to the right amplifies the band up to 12 dB. Turning it to the left cuts the band down to  $-12$  dB. At center, there is no effect (flat response).

- EQ LOW:** Turn the control to the right to boost bass frequencies and make the sound relatively heavy. Turn the control to the left to cut bass and make the sound thinner. The EQ shelving point is 100 Hz.

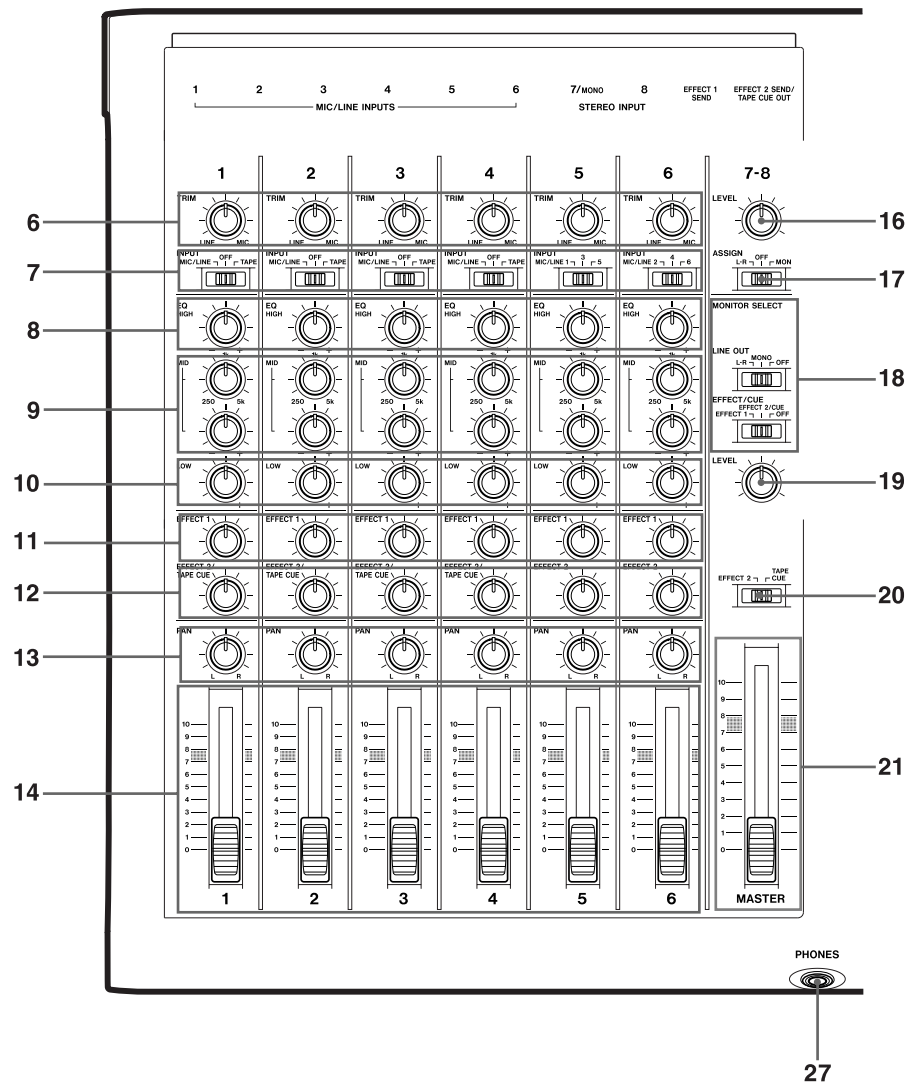

11. **EFFECT 1 send controls:** These controls get their signal from a point just after the channel fader (i.e., "post fader send") and route the corresponding channel signal to the EFFECT 1 SEND jack. Turn the control to the right to increase volume to the EFFECT 1 SEND jack.
12. **EFFECT 2/TAPE CUE controls:** These controls get their signal after the channel fader and route the signal to the EFFECT 2 SEND jack, or are used to adjust the tape playback level sent to the monitor section, as determined by the MONITOR EFFECT 2/TAPE CUE select switch.
13. **PAN controls:** This control allows you to create stereo mixes by sending the signal from the channel fader in continuously variable degrees to the left or right sides of the stereo mix at mixdown time.
14. **Channel Faders:** This linear control varies the level feeding the Master section. The nominal setting position is between 7 and 8 (shaded area).

#### Stereo Input Section

15. **STEREO INPUT jacks:** Connect the outputs of your effects devices to these 1/4" jacks. These jacks can also be used as additional line inputs. Nominal input level is -10 dBV (0.3 V).  
  
**Mono Feature:** If you connect a mono signal to the 7/MONO jack, the signal is sent to both the stereo left and right busses.
16. **LEVEL control:** This rotary control varies the level feeding the Master section. The nominal setting position is about 2 o'clock.
17. **ASSIGN switch:** This send the signal from the LEVEL control to the MASTER (L-R), switches it off entirely (OFF) or to the MONITOR LEVEL control (MON). If you are using these inputs for MIDI "virtual tracks", you should probably set this switch to MON while recording tape tracks, and L-R on mixdown.

#### Monitor Section

18. **MONITOR SELECT switches:** These switches determine what you will hear when monitoring.

The LINE OUT switch allows you to monitor in stereo (L-R), in mono (MONO) or turn off the L-R signals completely from the monitoring mix (OFF).

The EFFECT/CUE switch allows you to choose whether you will hear the EFFECT 1 send, the EFFECT 2 or TAPE CUE send (as determined by the position of the EFFECT 2/TAPE CUE switch), or neither of these (OFF).

19. **MONITOR LEVEL control:** This affects signal from the MONITOR select switch and sets the level you'll hear in the headphones/monitor speakers.

#### Master Section

20. **EFFECT 2/TAPE CUE select switch :** Depending on the setting of this switch, each channel's EFFECT 2/TAPE CUE control is switched to send the mic/line input to effects devices or the signal coming back from the recorder to the musicians in studio.
21. **MASTER fader :** Used to adjust the stereo mix level. The signal fed to this fader comes from each channel's PAN control. The safe operating zone is between 7-8 on the scale.

#### Output Section

22. **LINE OUTPUT L and R jacks:** These jacks are the line-level outputs from the MASTER fader. The L and R jacks are typically connected to your 2-track master recorder at MIXDOWN. The LINE OUTPUT jacks can also be used to send the mixer outputs of the 424 MKIII to the sub inputs of a larger mixer.
23. **MONITOR OUTPUT L and R jacks:** These provide a line level version of the same signal that feeds the PHONES jack and may be connected to your control room speaker amplifier.

24. **EFFECT 1 SEND jack** : The signal available at this jack comes from post-fader, for connection to effects devices. Nominal level is -10 dBV (0.3 V).

25. **EFFECT 2 SEND /TAPE CUE OUT jack**: This jack is for connection to an additional effects device, or to a studio speaker amplifier. The signal source is determined by the EFFECT 2/TAPE CUE select switch (# 20). Nominal output level is -10 dBV (0.3 V).

26. **TAPE OUTPUTS 1-4**: These jacks get signal directly from the tape (jack 1 from track 1, jack 2 from track 2, and so on). Use them if you want to mix the tape down with an external mixer or to make a backup copy of your master 4-track onto another tape recorder.

Sync tones recorded on track 4 are sent out of jack 4, for MIDI instruments to play synced up to the tape.

27. **PHONES jack (on the front panel)**: Connect any stereo headphones with a 1/4" stereo TRS 3-conductor plug to this jack.

28. **REMOTE PUNCH IN/OUT jack**: For connection to an optional RC-30P remote footswitch.

## 424 MKIII RECORDER

### Cassette Loading and dbx System

29. **Cassette compartment door**: To access the cassette compartment for inserting or removing a cassette, or cleaning the heads, etc., lift the door, using the tab at the lower right corner of the door. Once a cassette is inserted, be sure to close the door to prevent objects, dust or liquids from falling into the tape path.

#### Tape path components

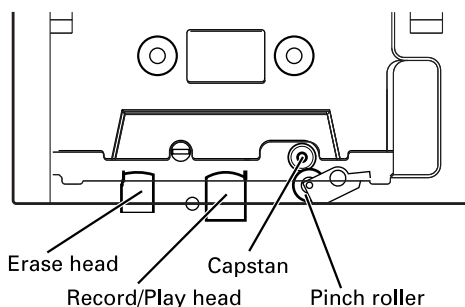

30. **DBX NR switch**: When this switch is set to its ON position, the built-in dbx noise reduction system for all 4 tracks is turned on. This is the normal position for all recording and playback.

When it is set to the SYNC position, Track 4 is disconnected from the dbx system, so the process does not affect the sync signals going to and from track 4, but tracks 1-3 still go through the dbx encode/decode process. Use the SYNC position for recording and playback of FSK sync or SMPTE time code.

The OFF position turns off the dbx noise reduction completely. Use this position when playing back tapes made with no noise reduction, or with Dolby B type NR.

The dbx NR system provides a net noise reduction (broadband, not just hiss) of about 30 dB, and also permits a net gain in tape headroom of about 10 dB, allowing recordings over a 90 dB dynamic range.



## Transport Controls

31. **REW key:** Winds tape at high speed in reverse direction.
32. **F FWD key:** Winds tape at high speed in the forward direction.
33. **STOP key:** Stops any tape motion and disables all transport modes.
34. **PLAY key:**
  - a) Press this key alone to start playback.
  - b) If pressed together with RECORD, recording ("punch in") starts.
  - c) Press this key during recording to stop recording ("punch out") without stopping tape motion.
35. **RECORD key:** Pressing this key alone has no effect. Pressing it together with PLAY (▶) activates either of two functions:
  - 1) Recording begins if one or more RECORD FUNCTION switches (#38) are previously set to a different position from SAFE and the track indicators blink in the meter window.
    - Recording can also be initiated by pressing RECORD during PLAY. See "PUNCH-IN or INSERT Recording", page 28.
  - 2) If all RECORD FUNCTION switches (#38) are in the SAFE position, the recorder will enter Record standby mode as indicated by a blinking RECORD LED.
36. **PITCH CONTROL dial:** Varies tape speed in record and play modes by up to approximately 12%. Turn the dial to the left to lower the speed, or to the right to increase the speed. Set the dial to the center "0" position to run tape at a standard speed of 9.5 or 4.8 cm/sec., as selected by the TAPE SPEED switch.

This can be used to save slightly out-of-tune parts, or to create sound effects such as flanging. Note that if you record with the dial at its maximum or minimum setting, you will NOT be able to make further adjustment in that direction upon playback.

**CAUTION:** The PITCH CONTROL dial affects recording speed also. Check to make sure that the dial is at its center "0" position unless you are using the function intentionally.

37. **TAPE SPEED select switch:** Controls the speed of the transport in both record and playback.

**HIGH** (3-3/4 i.p.s., 9.5 cm/sec.) is the position you should use for master recording, since it offers slightly better frequency response and signal-to-noise ratio than standard speed. In high speed, a C-60 offers 15 minutes of 4-track recording.

**NORMAL** is standard cassette speed of 1-7/8 i.p.s. (4.8 cm/sec.). It offers compatibility with other cassettes, acceptable sound quality for less critical work, and 30 minutes of recording on a C-60.

## Track Controls

38. **RECORD FUNCTION switches 1-4:** These switches put the respective tracks into Record Ready. Recording starts when RECORD is pressed after or together with PLAY.

In the center position (SAFE) no recording takes place.

**NOTE: Don't operate the RECORD FUNCTION switches to punch in and out. Otherwise, "clicks" will remain on tape.**

The RECORD FUNCTION switches also select what source will be recorded. For example, Track 1 can record either the single source plugged into Channel 1 of the mixer (DIRECT), or the entire BUSS L mix (which may have as many as six sources). The other RECORD FUNCTION switches work in the same way: either DIRECT from the same-numbered mixer channel, or from the MASTER stereo mix: Tracks 1 & 3 from BUSS L, Tracks 2 & 4 from BUSS R.

## Displays

39. **Track REC indicators:** They show the individual track's status as selected by the RECORD FUNCTION switches (#38).

Track REC indicator	Track status
Off	Safe
Blinking	Record Stand-by
Steady indication	Record

40. **Track level meters 1-4:** These meters show the record level coming either from each channel's fader or from the MASTER fader (the first and the third meters register the level from the left buss, the second and the fourth meters register the level from the right buss). If a track or tracks are in Safe mode the corresponding meters show the playback level.

41. **Monitor level meters:** These show the level in the monitor mix selected by the MONITOR switches (#18). The meters are "Pre" (before) the rotary MONITOR LEVEL control, so this control does not affect the meter readings.

42. **Tape counter:** Displays the distance the tape has moved from a zero reference point selected by pressing the COUNTER RESET key beneath.

43. **Other indicators:** Light up or blink depending on the selected mode and condition of your 424 MKIII.

## Autolocators

44. **RTZ (Return-To-Zero) key:** When this key is pressed in any transport mode, the tape will fast wind to the counter's zero (0000) point.

45. **LOC 1 key:** If pressed while the MEMO IN key (#47) is held down, it loads the current tape location into MEMO 1 register.

If pressed alone, it causes the tape to fast wind in either direction to the MEMO 1 point (if this point has been memorized).

This key is also used to check the memo point.

**NOTE:** To initiate autolocation, HIT the LOC key. To check the memo point, PRESS the key for 0.5 second or more.

46. **LOC 2 key:** Similar to the LOC 1 key, this key is used to establish a MEMO 2 point, and to locate tape with that memory point.

47. **MEMO IN key:** Used together with the LOC 1 and LOC 2 keys to load the current tape location into memory. See #45 and 46 above.

48. **REPEAT switch:** This provides a "playback loop" or "block repeat" between MEMO 1 and MEMO 2 points.



49. **CLEAR key:** Turns off the REHEARSAL and AUTO PUNCH IN/OUT functions (pp.30-31).

50. **COUNTER RESET switch:** This resets the COUNTER to "0000" so you can assign any point on the tape as a starting location. Pressing RTZ (#44) gets you back to that location.

51. **REHEARSAL switch:** Helps you rehearse a punch-in without erasing anything until you are ready to actually record (p.29).

52. **AUTO PUNCH switch:** Automates the punch-in/out sequence (Preroll, Punch-in, Punch-out and Postroll) you programmed in REHEARSAL mode (p.31).

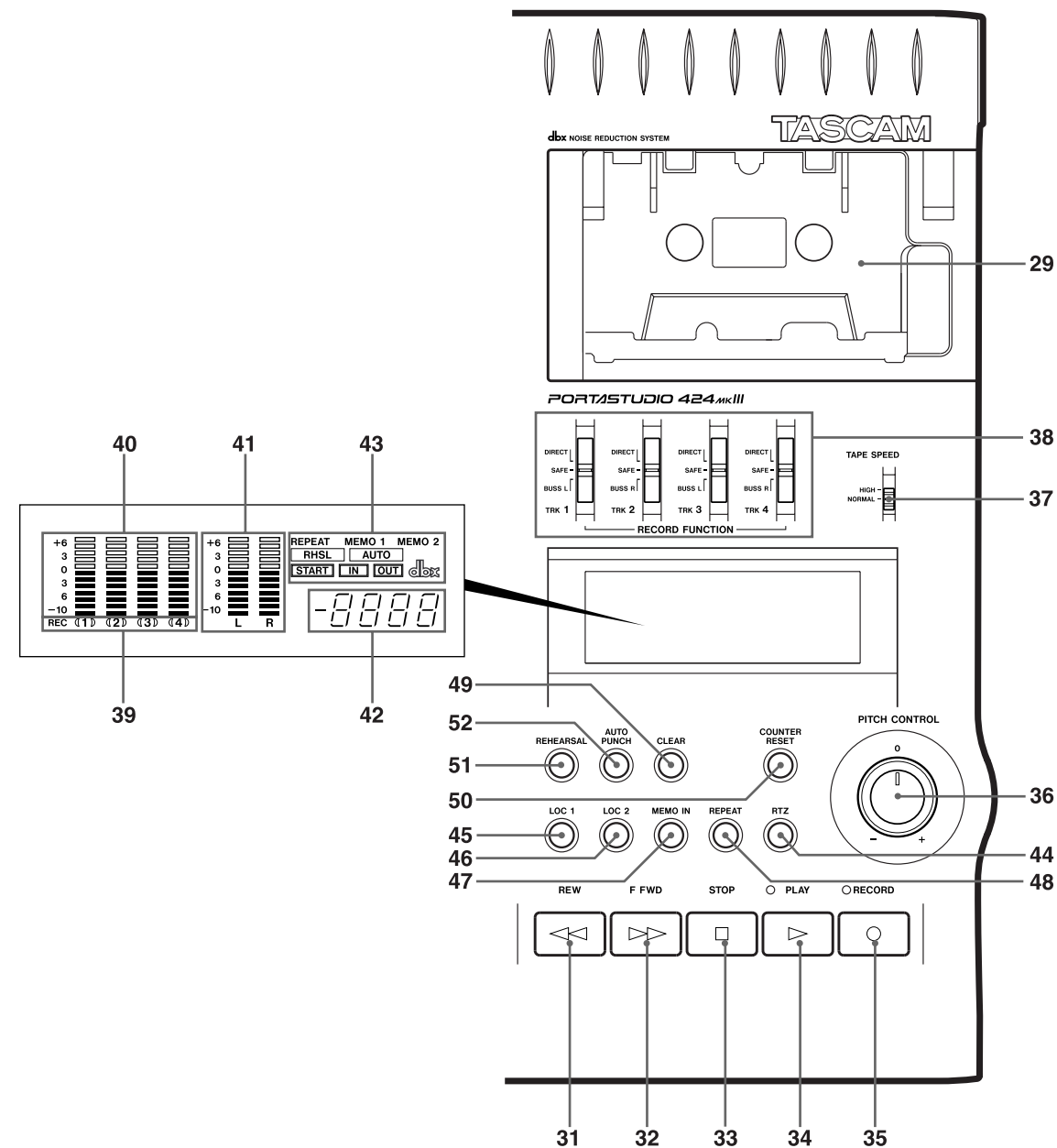
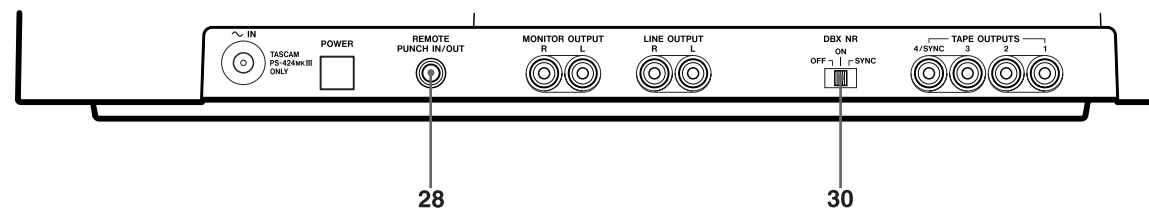

## Optional Accessories

RC-30P Remote Footswitch



MIDI-Tape Synchronizer



Head Demagnetizer



HC-1 Head Cleaner & RC-1 Rubber Cleaner (U.S. only)



TZ-261 Cleaning Kit (Except U.S.)



## Care and Maintenance

Even though the heads used in your 424 MKIII have high wear resistance and are rigidly constructed, performance degradation or electro-mechanical failure can be prevented if maintenance is performed regularly.

### CLEANING

The first things you will need for maintenance are not expensive. The whole kit with the swabs and fluids you will need for months will cost less than a couple of high quality cassettes.

We cannot stress the importance of cleaning too much. Clean up before each session. Clean up after every session. Clean up every time you take a break in the middle of a session.

### DEGAUSSING (DEMAGNETIZING)

A little stray magnetism can become quite a big nuisance in tape recording. It only takes a small amount (0.2 Gauss) to cause trouble on the record head. Playing 10 cassettes will put about that much charge on the heads. A little more than that (0.7 Gauss) will start to erase high frequency signals on previously recorded tapes. You can see that it's worth taking the trouble to degauss regularly.

A clean and properly demagnetized tape recorder will maintain its performance without any other attention for quite a while. It won't ruin previously recorded material, nor will getting it back to original specifications be difficult.

### Cleaning the Heads and Tape Guides

All heads and metal parts in the tape path must be cleaned after every 6 hours of operation, or before starting and after ending a recording session.

1. Open the cassette compartment door. Tape should not be loaded.
2. Hold STOP and REHEARSAL and press POWER to activate a Cleaning mode. "Cleaning" will show on the display.

**CLEANING MODE :** While in this mode, PLAY, F.FWD, REW, and STOP are effective, letting you get access to the head block, and rotate the capstan shaft and the pinch roller at high speed in either direction, or at normal play speed, making it easy to clean them as you perform the following steps.

3. Press PLAY (needless to hold it this time), so the head blocks move out.
  - If you leave the unit in Cleaning mode for 3 minutes after you have pressed PLAY, it will automatically go to STOP, the head block moving back.
4. Using a good head cleaning fluid and a cotton swab, clean the heads and tape guides until the swab comes off clean. Wipe off any excess cleaning fluid with a dry swab.

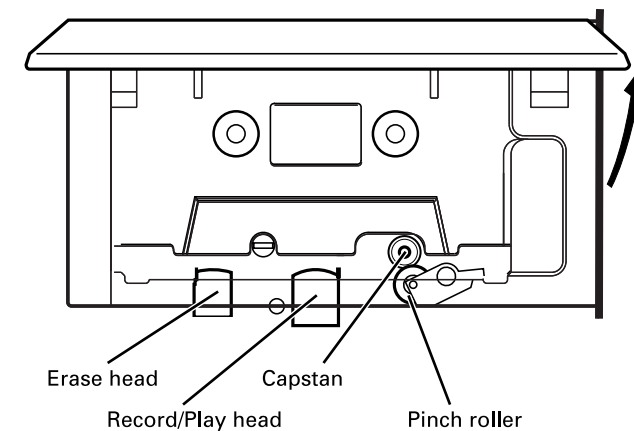

## How the dbx Works

### Cleaning the Pinch Roller

1. Press a cotton swab that has been moistened with rubber cleaner to the pinch roller on the right hand side of the capstan shaft (or, on the left hand side if REW is pressed). This will prevent the swab from becoming tangled in the mechanism.
2. Clean it until there is no visible residue coming off onto the swab.
3. Using a clean cotton swab, wipe off all the excess rubber cleaner from the pinch roller. Make certain that there is no foreign matter remaining on either the pinch roller or the capstan shaft.

### Cleaning the Capstan Shaft

1. Clean the capstan shaft by lightly pressing a cotton swab moistened with head cleaning fluid onto the shaft. Clean thoroughly and wipe off excess fluid.

### Degaussing the Tape Path

1. Hold the degausser about 1 m (3 feet) away from the recorder. Turn it on, slowly move in to the tape path. Move the degausser slowly back and forth, touching lightly all metal parts in the tape path. Slowly move it away again to at least 1 m (3 feet) from the recorder before turning it off.
2. To complete the cleaning and demagnetizing procedure, press STOP. The head block will retract. Then hold STOP and press COUNTER RESET to cancel the cleaning mode.

#### CAUTION

If the surface of the unit gets dirty, wipe the surface with a soft cloth or use a diluted neutral cleaning fluid. Clean off thoroughly. Do not use thinner, benzene, or alcohol, as they may damage the surface of the unit.

The dbx is a wide-band compression-expansion system which provides a net noise reduction (broadband, not just hiss) of a little more than 30 dB. In addition, the compression during recording permits a net gain in tape headroom of about 10 dB.

A compression factor of 2:1 is used before recording; then, 1:2 expansion on reproduce. These compression and expansion factors are linear in decibels and allow the system to produce tape recordings with over a 90 dB dynamic range – an important feature, especially when you're making live recordings. The dbx employs RMS level sensors to eliminate compressor-expander tracking errors due to phase shifts in the tape recorder, and provides excellent transient tracking capabilities.

To achieve a large reduction in audible tape hiss, without danger of overload or high-frequency self-erasure on the tape, frequency pre-emphasis and de-emphasis are added to the signal and RMS level sensors.

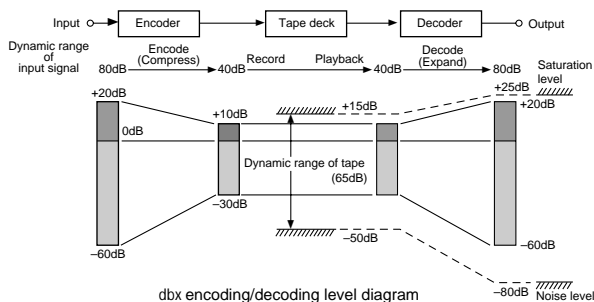

### SUBSONICS AND INTERFERENCE

The dbx incorporates an effective bandpass filter. This filter suppresses undesirable subsonic frequencies to keep them from introducing errors into the encode or decode process. However, if rumble from trains or trucks is picked up by your microphone and fed to the dbx, modulation of the program material during low level passages may occur. This low-frequency component will not itself be passed through the recorder and so, will not be present at reproduce for proper decoding. If this low-level decoding error is encountered, and subsonics are suspected, we suggest the addition of a suitable high-pass filter in the microphone line.

# Specifications

---

## Mechanical Characteristics

<b>Tape:</b>	Compact Cassette (C-30 to 90), High-Bias (CrO <sub>2</sub> )
<b>Track Format:</b>	4-track/4-channel
<b>Head Configuration:</b>	4-channel record/play (permalloy) x 1 4-channel erase (ferrite) x 1
<b>Motor:</b>	DC servo motor x 1
<b>Tape Speed:</b>	Switchable two speeds: 9.5 cm/sec. (3-3/4 ips) and 4.8 cm/sec. (1-7/8 ips), ± 1%
<b>Pitch Control:</b>	± 12 % (approx.)
<b>Wow and Flutter:</b>	0.06% WRMS at 4.8 cm/sec., 0.05% WRMS at 9.5 cm/sec.
<b>Fast Winding Time:</b>	120 sec. (approx.) with C-60
<b>Dimensions (W × H × D)</b>	419 x 115 x 357 mm (16-1/2" x 4-1/2" x 14-1/16")
<b>Weight:</b>	4.9 kg (10.8 lbs.)

## Electrical Characteristics

### Mixer Section

#### MIC/LINE INPUT, Ch.1-4

(XLR type connector x 4)

<b>Input Impedance:</b>	3.6k ohms
<b>Nominal Input Level:</b>	-60 dBV (1mV) (MIC position) -20 dBV (0.1 V) (LINE position)
<b>Maximum Input Level:</b>	+3 dBV (1.4 V) at Trim Min.

#### MIC/LINE INPUT, Ch.1-6

(1/4" phone jack x 6)

<b>Input Impedance:</b>	5.6k ohms
<b>Nominal Input Level:</b>	-50 dBV (3mV) (MIC position) -10 dBV (0.3 V) (LINE position)
<b>Maximum Input Level:</b>	+10 dBV (3 V) at Trim Min.

#### STEREO INPUT, Ch.7-8

(1/4" phone jack x 2)

<b>Input Impedance:</b>	10k ohms
<b>Nominal Input Level:</b>	-10 dBV (0.3 V)
<b>Maximum Input Level:</b>	+10 dBV (3 V)

#### SUB INPUT (RCA jack x 2)

<b>Input Impedance:</b>	10k ohms
<b>Nominal Input Level:</b>	-10 dBV (0.3 V)
<b>Maximum Input Level:</b>	+10 dBV (3 V)

#### LINE OUTPUT (RCA jack x 2)

<b>Output Impedance:</b>	100 ohms
<b>Nominal Output Level:</b>	-10 dBV (0.3 V)
<b>Minimum Load Impedance:</b>	2k ohms

#### EFFECT 1 SEND (1/4" phone jack)

<b>Output Impedance:</b>	100 ohms
<b>Nominal Output Level:</b>	-10 dBV (0.3 V)
<b>Minimum Load Impedance:</b>	2k ohms

---

**EFFECT 2 SEND/TAPE CUE OUT**

(1/4" phone jack)

**Output Impedance:** 100 ohms  
**Nominal Output Level:** -10 dBV (0.3 V)  
**Minimum Load Impedance:** 2k ohms

**TAPE OUTPUT (RCA jack x 4)**

**Output Impedance:** 100 ohms  
**Nominal Output Level:** -10 dBV (0.3 V)  
**Minimum Load Impedance:** 2k ohms

**MONITOR OUTPUT (RCA jack x 2)**

**Output Impedance:** 690 ohms  
**Nominal Output Level:** -10 dBV (0.3 V)

**PHONES (1/4" stereo phone jack x 1)**

**Nominal Load Impedance:** 30 ohms  
**Maximum Output Level:** 60 mW (approx.)

**Equalizer**

**HIGH (Shelving):** 10 kHz,  $\pm 10$  dB  
**MID (Parametric):** 250 Hz to 5 kHz,  $\pm 12$  dB  
**LOW (Shelving):** 100 Hz,  $\pm 10$  dB

**Frequency Response:**

**MIC INPUT to LINE OUTPUT:** 20 Hz to 20 kHz  $\pm 3$  dB  
**LINE INPUT to LINE OUTPUT:** 20 Hz to 20 kHz  $\pm 2$  dB  
**LINE INPUT to EFFECT OUTPUT:** 20 Hz to 20 kHz  $\pm 2$  dB  
**LINE INPUT to PHONES:** 40 Hz to 20 kHz  $\pm 3$  dB

**Signal-to-Noise Ratio**

(20 Hz to 20 kHz, B.P.F. inserted)

**1 MIC INPUT to LINE OUTPUT** 65 dB (at a nominal input level of -60 dBV)  
**4 MIC INPUTS to LINE OUTPUT** 60 dB (at a nominal input level of -60 dBV)  
**1 LINE INPUT to LINE OUTPUT** 76 dB (at a nominal input level of -10 dBV)  
**4 LINE INPUTS to LINE OUTPUT** 70 dB (at a nominal input level of -10 dBV)

**Distortion**

**1 MIC INPUT to LINE OUTPUT** 0.05% (at 1 kHz, 15 dB above nominal input level with 30 kHz low-pass filter inserted)  
**1 LINE INPUT to LINE OUTPUT** 0.04% (at 1 kHz, nominal input level with 30 kHz low-pass filter inserted)

**Crosstalk:** 55 dB (at 1 kHz, nominal input level with 30 kHz low-pass filter inserted)

**Recorder Section**

**Record/Play channels:** 4/4

**Noise Reduction:** dbx TYPE II

**Frequency Response (overall):** 40 Hz to 16 kHz,  $\pm 3$  dB at 9.5 cm/sec.,  
40 Hz to 10 kHz,  $\pm 3$  dB at 4.8 cm/sec.

**Signal-to-Noise Ratio (overall):** UNWTD (20 Hz to 20 kHz)/IHF A WTD

**HIGH:** 55 dB/58 dB (without dbx); 90/95 dB (with dbx)  
**NORMAL:** 54 dB/56 dB (without dbx); 88/93 dB (with dbx)

**Total Harmonic Distortion:** 1.0% (1 kHz)

**Crosstalk (Channel Separation):** 55 dB or better

**Erasure:** 65 dB or better (at 1 kHz, B.P.F. inserted)

**Others**

**Power Requirements**

**USA/CANADA:** 120 V AC, 60 Hz

**U.K./EUROPE:** 230 V AC, 50 Hz

**AUSTRALIA:** 240 V AC, 50 Hz

**Power Consumption:** 22 W

In these specifications, 0 dBV is referenced to 1 Volt. Actual voltage levels are also given in parentheses (0.316 V for -10 dBV rounded off to 0.3 V).

\* dbx is a registered trademark of dbx Incorporated.

■ Changes in specifications and features may be made without notice or obligation.

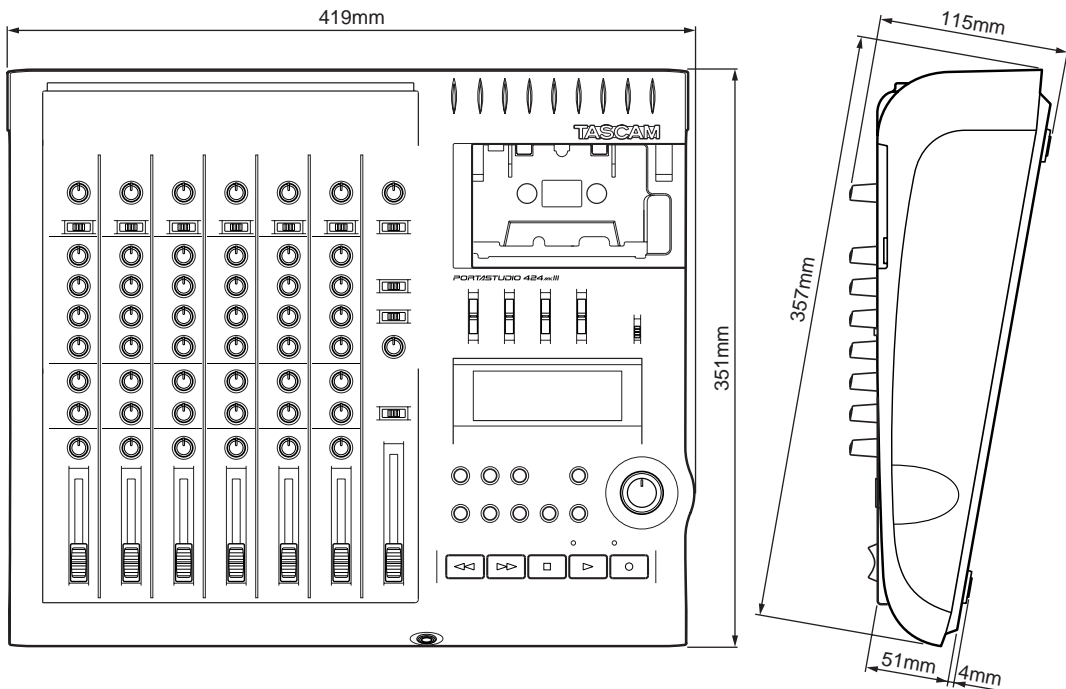

# Block Diagram

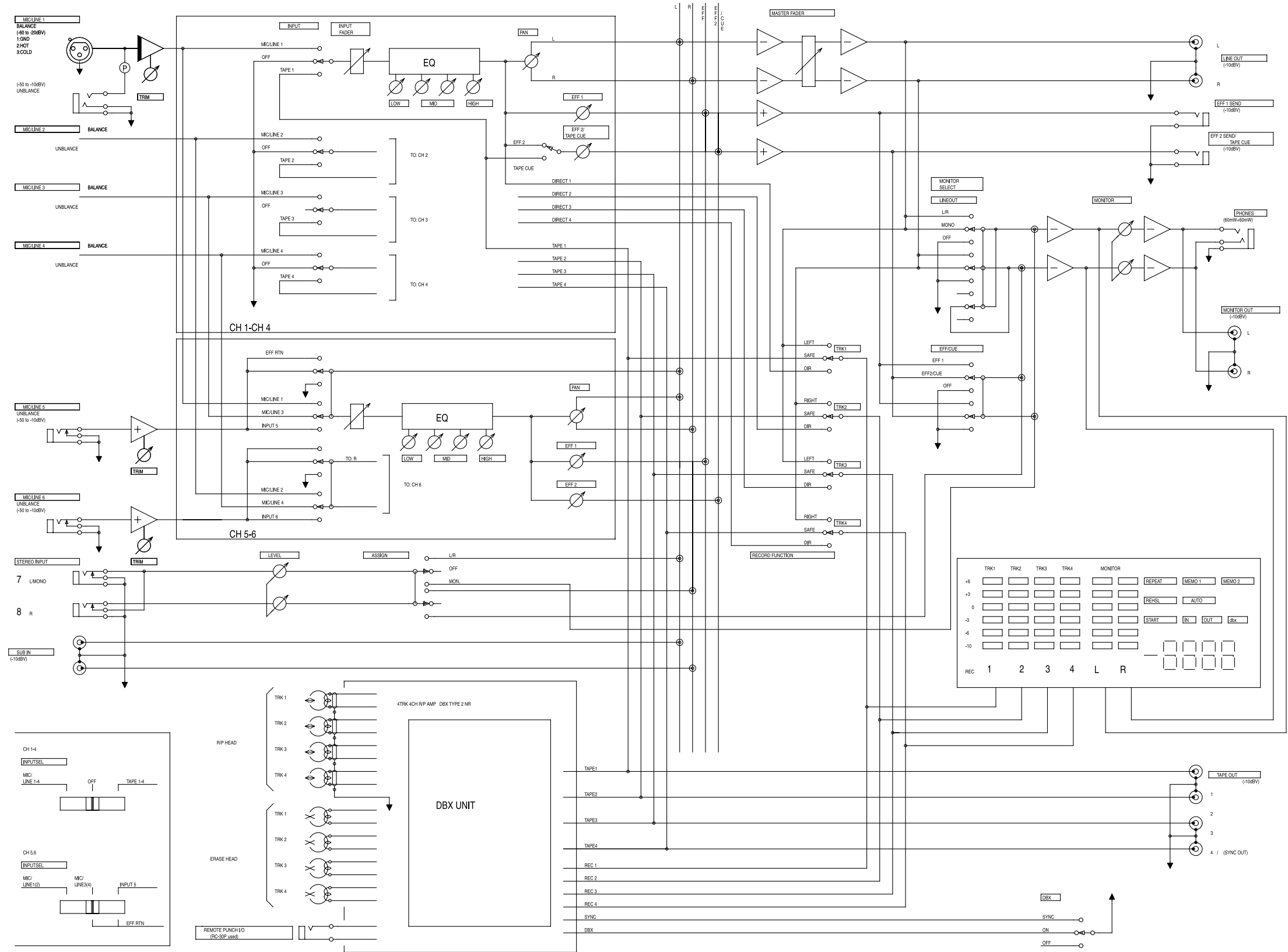

# Level Diagram

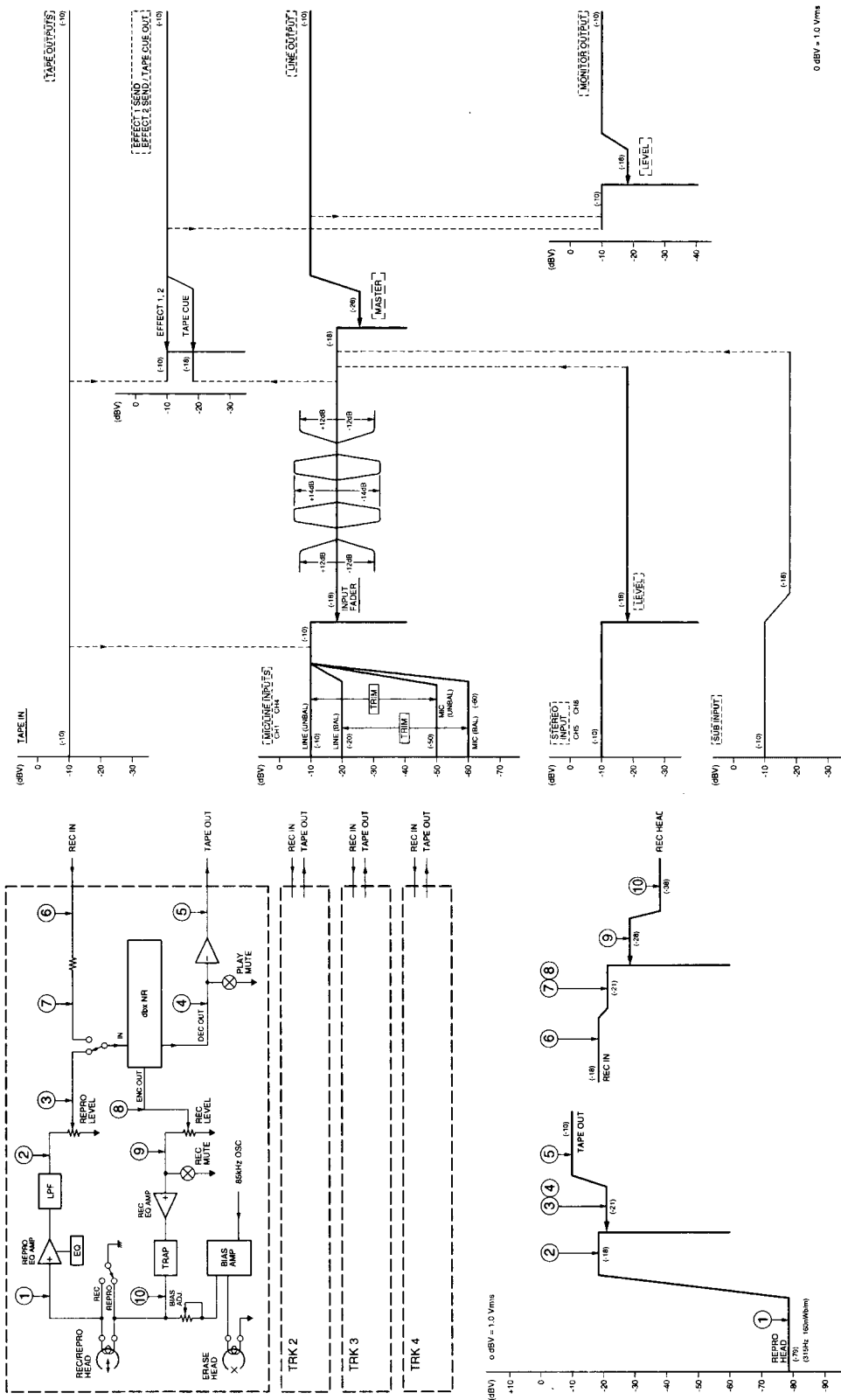

# TASCAM

## TEAC Professional Division

# 424MKIII

## PORTASTUDIO

### TEAC CORPORATION

3-7-3, Nakacho, Musashino-shi, Tokyo 180-8550, Japan Phone: (0422) 52-5082

TEAC AMERICA, INC.

7733 Telegraph Road, Montebello, California 90640 Phone: (323) 726-0303

TEAC CANADA LTD.

5939 Wallace Street, Mississauga, Ontario L4Z 1Z8, Canada Phone: 905-890-8008 Facsimile: 905-890-9888

TEAC MEXICO, S.A. De C.V.

Privada De Corina, No.18, Colonia Del Carmen Coyoacan, Mexico DF 04100 Phone: 5-658-1943

TEAC UK LIMITED

5 Marlin House, Marlins Meadow, The Croxley Centre, Watford, Herts. WD1 8YA, U.K. Phone: 01923-819699

TEAC DEUTSCHLAND GmbH

Bahnstrasse 12, 65205 Wiesbaden-Erbenheim, Germany Phone: 0611-71580

TEAC FRANCE S.A.

17 Rue Alexis-de-Tocqueville, CE 005 92182 Antony Cedex, France Phone: 01.42.37.01.02

TEAC BELGIUM NV/SA

P.A. TEAC Nederland BV, Perkinsbaan 11a, 3439 ND Nieuwegein, Netherlands Phone: 0031-30-6048115

TEAC NEDERLAND BV

Perkinsbaan 11a, 3439 ND Nieuwegein, Netherlands Phone: 030-6030229

TEAC AUSTRALIA PTY., LTD.  
A.C.N. 005 408 462

106 Bay Street, Port Melbourne, Victoria 3207, Australia Phone: (03) 9644-2442

TEAC ITALIANA S.p.A.

Via C. Cantù 11, 20092 Cinisello Balsamo, Milano, Italy Phone: 02-66010500